

DIAMOND C-40 Series

Low Power CO₂ OEM Lasers for Marking and Engraving Applications

The Coherent C-40 CO₂ laser provides 40 Watts of power with best-in-class reliability and package size, making it the OEM laser of choice for high performance laser marking and engraving systems. This production-ready, easy-to-integrate laser system enables high quality laser marking with low maintenance and operating costs. The C-40 is ideal for laser processing of many materials, including paper, plastics, wood, leather, cloth and more.

The C-40 is part of the Coherent C-Series family of products which offer a full range of power levels – from 20 W to 70 W. Based on a sealed waveguide and integrated RF power supply design, the C-40 boasts outstanding production-proven reliability (lifetime >50,000 hours), while delivering superior beam quality and power stability in a compact, flexible and integrated package. The modular platform design provides cost-effective optimization of operating wavelength (from 9.3 to 10.6 μm) and cooling configuration (air/liquid), enabling rapid adaptability to changing applications and market needs.

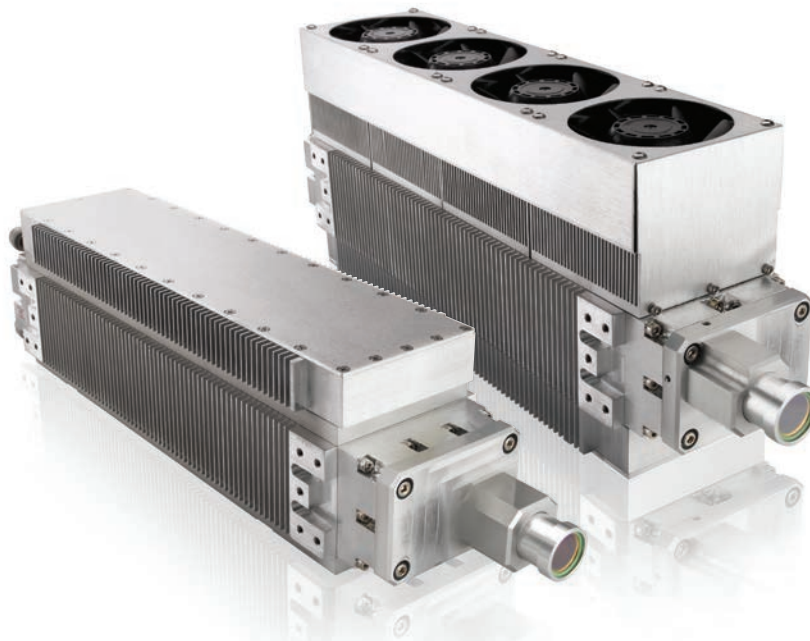

FEATURES

- Versatile power range with high stability and reliability
- Industry leading compact size with integrated RF power supply
- High quality laser processing on a wide range of materials
- Wide power range with constant wave (CW) or pulse width modulation (PWM) control
- Available in multiple wavelength and cooling configurations (air or liquid)

APPLICATIONS

- Marking
- Engraving
- Cutting

DIAMOND C-40 Series

Specifications ¹	DIAMOND C-40A (10.2 μm)	DIAMOND C-40A	DIAMOND C-40L (10.2 μm)	DIAMOND C-40L
Wavelength (μm)	10.11 to 10.31	10.55 to 10.63	10.11 to 10.31	10.55 to 10.63
Optical Output Power ¹ (W)	40			
Power Stability ² (%)	±5			
Mode Quality (M ²)	<1.3			
Beam Size (mm)	3.6 ±0.5 at output aperture			
Beam Divergence (mrad, full angle)	<5			
Polarization	>100 to 1 (fixed linear, parallel to width dimension)			
Operating Frequency and Duty Cycle	0 to 200 kHz, 0 to 100% DC			
Size (standard configuration)				
Weight	6.8 kg (15.0 lbs.)		6.4 kg (14.0 lbs.)	
Dimensions (L x W x H)	425.0 x 92.5 x 154.5 mm (16.73 x 3.64 x 6.08 in.)		460.8 x 92.5 x 104.1 mm (18.15 x 3.64 x 4.1 in.) ³	
Input Power ⁴	48 VDC, 13A			
Cooling	Air		Liquid	
Heat Dissipation (W)	<675			
Maximum Case Temperature	<60°C (140°F)			
Operating Environment Temperature Altitude Humidity	5 to 40°C (41 to 113°F) <2000 m (6500 ft.) Non-condensing			
Shipping/Storage Environment	-10 to 60°C (14 to 140°F), non-condensing			
Coolant Coolant Flow Rate Maximum Coolant Pressure Max. Pressure Differential (at 1.0 gpm) Coolant Temperature	Distilled water with 25 to 35% Dow Frost ⁵ >3.8 lpm (1.0 gpm) 6.9 bar (100 psig) 1.5 bar (22 psig) 15 to 30°C (59 to 86°F)			

Notes:

1. Power measured at 25°C and derated by 1%/C for higher laser head temperatures.
2. Power stability based on $\pm(P_{max} - P_{min}) / (2 * P_{max})$ average power measurement at constant duty cycle after 10-minute warm-up at operating condition.
3. The overall height dimension is taller for the Dual Chillplate version of this item.
4. Optional fans add 1A.
5. Dow Frost is a trademark of the Dow Chemical Company.

Mechanical Specifications

Diamond C-40A Laser Head

Top View

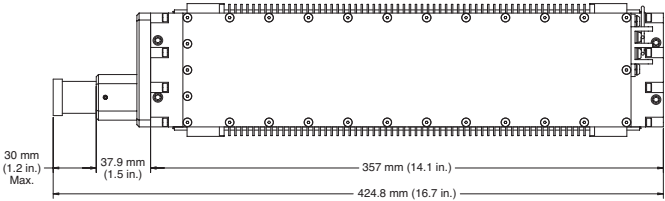

Front View

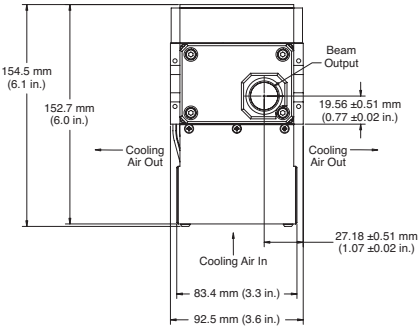

Side View

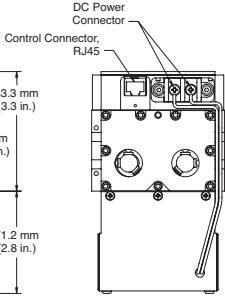
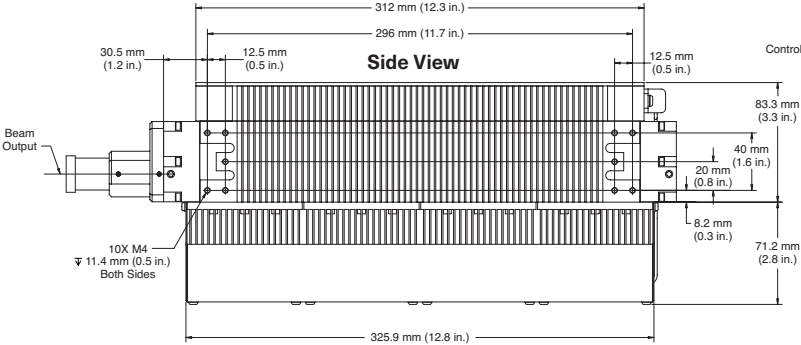

Rear View

Bottom View

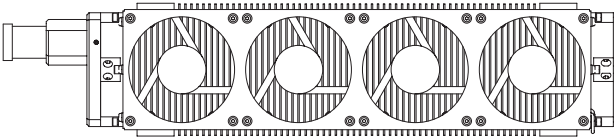

Mechanical Specifications

Diamond C-40L Laser Head

Top View

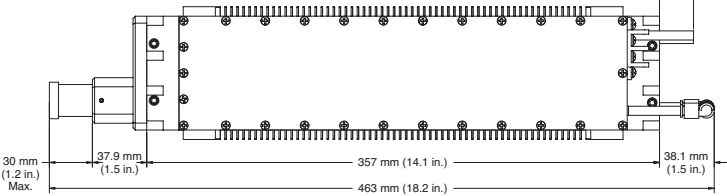

Front View

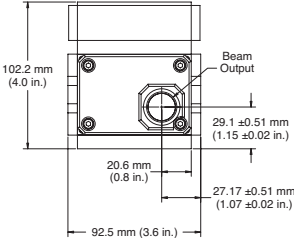

Side View

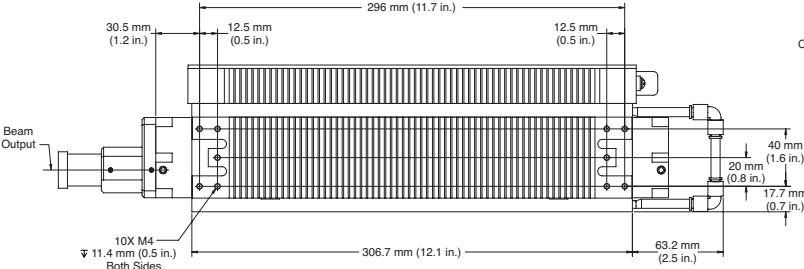

Rear View

