

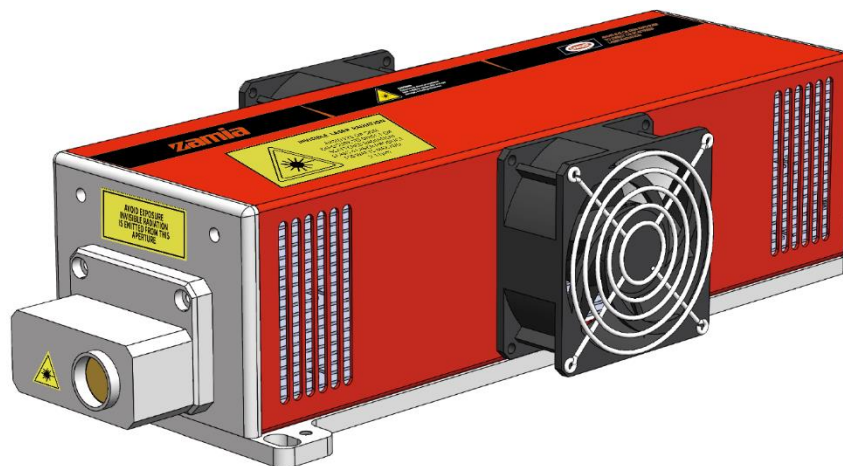

OPERATORS MANUAL

N30Pro CO₂ RF LASER



Content

| | |
|--|-----------|
| Chapter 1 Introduction | 1 |
| 1.1 Trademark, copyright, version and model | 1 |
| 1.2 EC Declaration of Conformity..... | 2 |
| 1.3 Warranty..... | 3 |
| 1.4 Unpacking/packing, storage/transportation, mounting, wiring and cooling..... | 3 |
| 1.5 Content description | 4 |
| 1.6 Packing contents | 4 |
| Chapter 2 Safety Instructions and Preventive Measures | 5 |
| 2.1 Overview | 5 |
| 2.2 Hazard Labels | 6 |
| 2.3 Safety precautions..... | 7 |
| 2.4 Safety precautions..... | 8 |
| Chapter 3 Product Overview | 8 |
| 3.1 Brief | 8 |
| 3.2 Application..... | 8 |
| 3.3 Parameters and working conditions..... | 9 |
| 3.4 Operation mode | 10 |
| 3.5 Product structure | 11 |
| Chapter 4 Mounting | 13 |
| 4.1 Outline & Mounting drawing | 13 |
| 4.2 Environmental conditions..... | 14 |
| 4.3 Wiring | 15 |
| 4.4 DC cable | 15 |



| | |
|---|-----------|
| 4.5 Power supply system | 15 |
| 4.6 Cooling..... | 17 |
| 4.7 Control | 18 |
| 4.8 Protection for optical path | 19 |
| 4.9 Fixing..... | 20 |
| Chapter 5 Control and Operation | 21 |
| 5.1 Operation flow chart..... | 21 |
| 5.2 Preparation for operation..... | 22 |
| 5.3 Control Terminal | 22 |
| 5.4 Power input & D-SUB connector | 23 |
| 5.5 Indicators | 25 |
| 5.6 Start and pulse operation..... | 26 |
| 5.7 Cautions for Safe Laser Operation..... | 27 |
| Chapter 6 Technical Reference | 28 |
| 6.1 Laser Resonator | 28 |
| 6.2 Heat dissipation | 28 |
| 6.3 Laser beam | 29 |
| 6.4 Backward reflection beam isolation principle..... | 29 |
| 6.5 Construction of external optical path and optics protection | 30 |
| 6.6 RF power supply..... | 30 |
| 6.7 Modulation signal & pulse width modulation..... | 31 |
| 6.8 Marking & Engraving | 31 |
| Chapter 7 Maintenance..... | 32 |
| Chapter 8 Questions & Answers..... | 33 |



Chapter 1 Introduction

1.1 Trademark, copyright, version and model

Trademark

ZAMIA® is a registered trademark of SPT Laser Technology Co., Ltd, and all other Zamia trademarks are owned by SPT Laser Technology Co., Ltd.

Copyright

This manual is the English version of SPTOM-EN30Pro edited in January, 2022, and all rights reserved by SPT Laser Technology Co., Ltd. Reproduction, plagiarism and copy of this manual, or of this manual in other languages, are strictly prohibited without the written authorization of SPT Laser Technology Co., Ltd.

Edition

This manual is the English version of SPTOM-EN30Pro-22.01, and the product model is N30Pro CO2 RF excited laser.

Please refer to this manual when using and operating N30Pro CO2 laser. For the manual of the latest product, please refer to our website.

Model

N30Pro dissipates heat by air cooling. Special band models such as N30iPro, the representative laser model is: air-cooled 9.3um band. There is slightly difference on power and wavelength between N30iPro and N30Pro, other parameters are the same.

N30Pro+ is a customized version for customers, which can provide a variety of personalized customization schemes such as coaxial red light and built-in beam expander (3x/4x/5x optional).

Note: The similarities of information are referred to as N30Pro for short. For detailed information about the product, please refer to this manual.



1.2 EC Declaration of Conformity



We,

Manufacturer: SPT LASER TECHNOLOGY CO.,LTD

Address: No.4 Floor 1, Communication Technology Building, Wandao Road, Wanjiang District, Dongguan, Guangdong, China

Hereby declared that,

Product Name: CO2 RF LASER
Trade Mark: ZAMIA
Model No.: N5, N10, N30, Q150, Q180, Q200, Q260, Q300, F6, F8, F10, H4, H5, N5i, N10i, N30i, Q150i, Q180i, Q200i, Q260i, Q300i, F6i, F8i, F10i, H4i, H5i.

The object(s) of the declaration described above is in conformity with the following relevant Union harmonisation legislation(s):

- 2006/42/EC Machinery Directive
- 2014/30/EU EMC Directive
- 2011/65/EU RoHs Directive

Conformity with the Directives is demonstrated by full compliance of the product with all applicable specifications of the following standards:

- EN 60204-1:2018
- EN 60825-1:2014+A11:2021
- EN 61000-6-2: 2019
- EN 61000-6-4: 2019

This declaration of conformity is issued under the sole responsibility of the manufacturer.

Signed for and on behalf of,

Place: Jiangsu, China

Name and Position: Huaqin Luo, Quality Manager

Date: June 27, 2022

Signature:  



1.3 Warranty

Warranty

The warranty period is 24 months from the date of delivery. Please check the laser within 7 days after receiving it, and if there is any problem, contact SPT Laser Technology Co., Ltd soon.

During the warranty, if the your N30Pro laser presents a performance failure that is not artificially damaged, please provide the delivery date, equipment model, serial number, and a brief description (about the problem), keep the factory identification of the equipment intact, and contact SPT Laser Technology Co., Ltd to report the problem.

The following conditions are not covered by the warranty:

1. Artificial damage
2. Warranty expired
3. There is no warranty card or valid invoice or the sealed label on the laser is damaged.
4. Damage caused by failure to adjust, install, use and maintain according to the manual.
5. Disassembly and repairment of the equipment without authorization of SPT Laser Company.
6. Damage caused by force majeure

Service

After-sale Service: support@laserwd.com

For more information, please visit www.sptlaser.net.

1.4 Unpacking/packing, storage/transportation, mounting, wiring and cooling

It is recommended that you keep the original packing box of the laser to prevent the laser from being damaged during transportation and storage.

Please refer to this manual for other information.



1.5 Content description

N30Pro CO2 RF excited laser is used for cutting, drilling, marking nonmetallic materials and medical cosmetology.

The laser needs DC power supply, and the recommended DC power supply is 48V/12.5A. The cable connecting the DC power supply and the laser requires multi-strand wound flexible wires. The diameter of the inner core should be greater than 3mm but less than 4mm, and the insulation layer should have good insulation performance. The length of the cable should not be longer than 4m on one side.

N30Pro CO2 RF excited laser dissipates heat by air cooling, and the laser has its own cooling fan. If there is a lot of dust in the ambient air, it is necessary to add a sealed enclosure outside the laser, and a fan should be added to the enclosure (with a filter screen on the enclosure) to force the air to circulate. The filter screen should be cleaned regularly, otherwise it will lead to poor heat dissipation, leading to power attenuation and even damage of the laser!

Examination on equipment ventilation: If the ventilation is sound, the temperature of the laser will rise by $\leq 20^{\circ}\text{C}$ after it is turned on.

* The ambient temperature shall be between 5°C and 40°C , and the maximum temperature of the laser surface shall be below 60°C .

When N30Pro CO2 laser runs in an environment of high humidity, it is necessary to check if there is dew condensation on the surface and window lens of the laser. If so, it means that the ambient humidity is too high. If necessary, please install an air conditioner to reduce the ambient humidity. When the laser does not work for long, the power supply to the laser should be cut off and the heat dissipation should be stopped. When it is used in the case of heavy dust, it is necessary to conduct dust prevention. The light path should be sealed at the joint of each interface, and rubber rings should be used.

If you need to blow the laser, please use nitrogen of high purity or clean air filtered with water, oil and dust.

1.6 Packing contents

N30Pro CO2 laser *1
D-SUB female connector *1
Ex-factory test report *1
Brief wiring instructions *1

Chapter 2 Safety Instructions and Preventive Measures

2.1 Overview

According to China's national standard GB7247.1-2001(IEC60825-1:1993) for the classification of laser products, this product belongs to Class 4 laser products, which may cause dangerous refraction, reflection and diffuse reflection, and may cause human injury or fire. Be especially careful when using it!

Before transporting, installing, operating and maintaining the laser, please read this manual first, and use the laser correctly according to the contents in the manual to ensure the safety of personnel and normal use. Wrong operation may cause damage to the laser.

Please refer to the safety prompt and warning signs in this manual.

DANGER The dangerous laser output is Class 4 laser invisible to the naked eye. It is forbidden to look directly at the laser, reflect or diffuse reflect of the laser on the surface of the object. The direct laser may cause serious damage to the cornea, so the operator must wear professional protective glasses for laser. Laser will cause serious harm to human body, so avoid laser irradiation, reflection or diffuse scattering to human body or surrounding objects. It is forbidden to use lasers in explosive or easily-explosive environments.

WARNING Please take laser safety-protection measures. Toxic and harmful dust or gas may be produced during laser processing. Effective smoke exhaust or ventilation conditions should be provided.

ATTENTION Please pay attention to the transportation, installation, operation and maintenance of the laser in strict accordance with the instructions. Wrong operations may cause damage to the laser. Please don't use organic materials or metal as beam baffle. Organic matter is easy to burn or melt, and metal may cause laser specular reflection, which will harm the operators. Do not disassemble or repair the laser at will, which may cause unknown risks. If you find any damage to the laser accessories, please do not operate the equipment, contact SPT Laser Technology Co., Ltd and report the problem.



2.2 Hazard Labels

There are 4 laser hazard labels attached onto the surface of N30Pro/N30Pro+ CO2 lasers. Please refer to its locations as below.

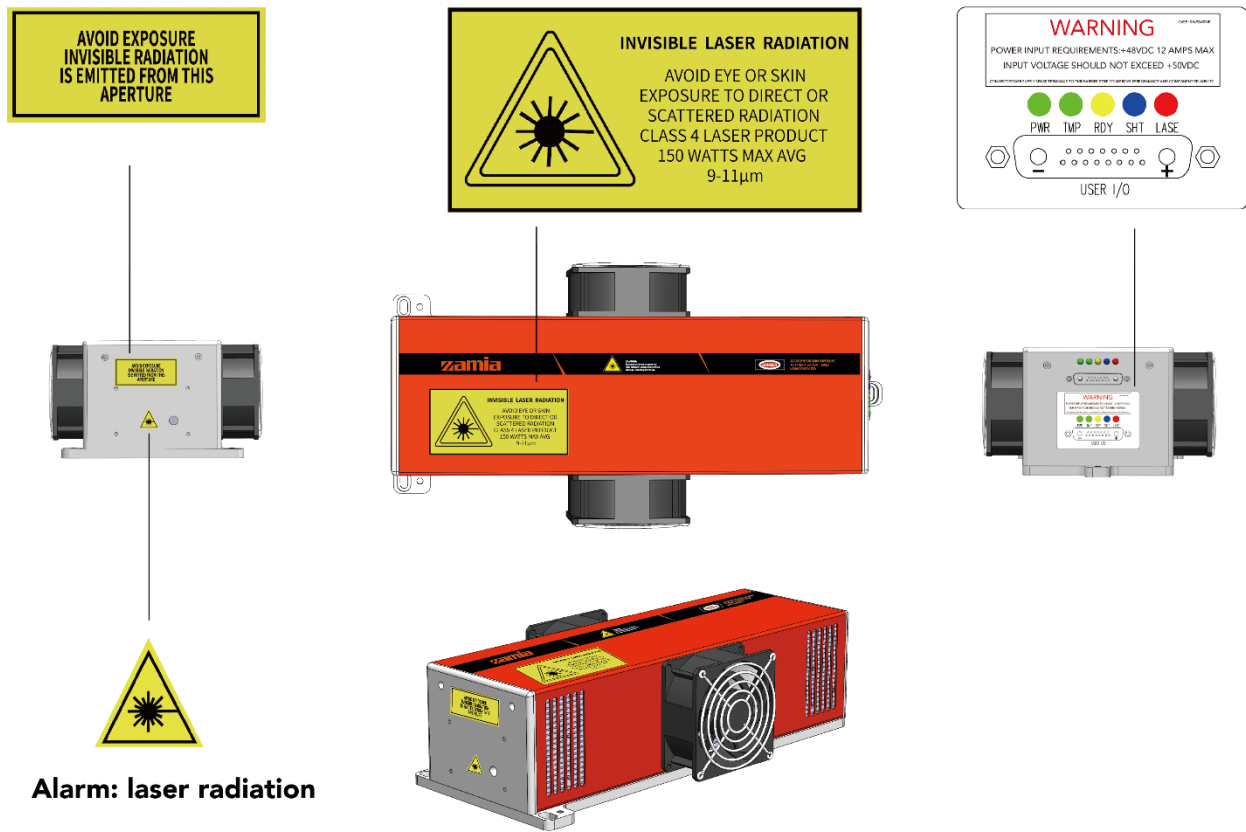

Schematic diagram of label position of N30Pro CO2 RF excited laser

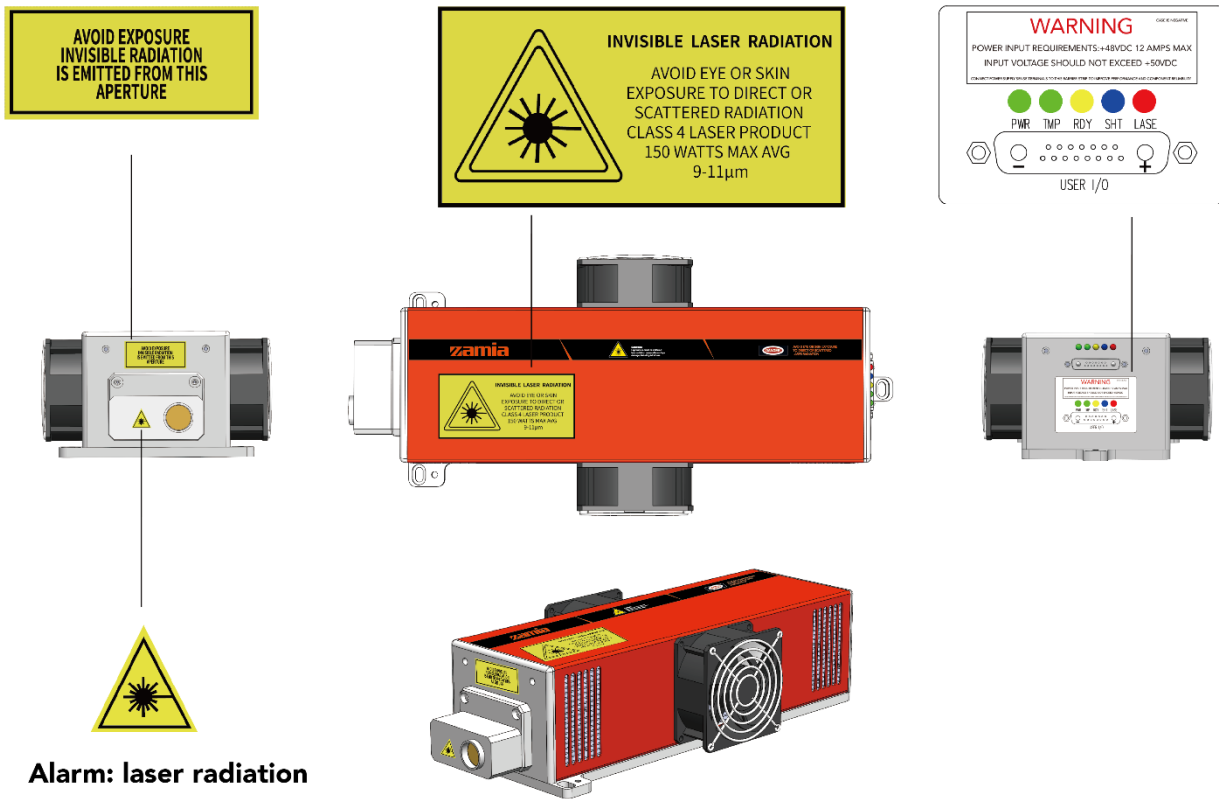

Schematic diagram of label position of N30Pro+ CO2 RF excited laser

2.3 Safety precautions

1. Be sure to wear laser goggles to reduce the damage to the eyes when operating the laser.
2. In the working area of the laser, please do not touch your body or any flammable materials. The laser beam will cause serious skin burns.
3. Do not process mirror materials with high reflectivity, so as to avoid mirror reflection of laser beam, which will cause serious harm to equipment or operators.
4. Don't use organic materials and metals as beam blockers. Organic materials are easy to burn or melt, and metals can reflect laser beams.
5. Do not disassemble or modify the laser by yourself, so as to avoid safety accidents, otherwise the equipment cannot be guaranteed.
6. Please ensure that the equipment is used in the working space of good ventilation, otherwise the internal temperature of the equipment will rise and the equipment will be damaged.



2.4 Safety precautions

1. Use the emergency stop switch.

In case of emergency, it is used to cut off the power supply of the equipment, terminate the power supply of the whole machine and stop the laser output.

2. Set up warning signs and control areas.

Set up warning signs and blocking devices in areas that may be directly or indirectly irradiated by laser.

3. Be equipped with fire extinguisher.

To prevent fire, please place a carbon dioxide fire extinguisher or dry powder fire extinguisher near the place where the equipment is installed.

Chapter 3 Product Overview

3.1 Brief

- The RF power supply and the cavity are one-package design, which is simple and easy to integrate;
- All-metal structure, sealed design, maintenance-free;
- High photoelectric conversion efficiency and fast modulation response;
- Excellent beam quality and stable power output;
- Applicable to various industrial environments, with a service life of 20,000 hours.

3.2 Application

N30Pro CO2 laser can be used for medical cosmetology, laser cutting, laser marking, plastic welding and 3D printing.

Processing of leather, stone, wood, plastic and other materials.

Processing of special materials, such as ABS, Teflon, asbestos, rubber, etc.

Works well for moles, age spots, warts and corns removal in medical treatment.



3.3 Parameters and working conditions

Basic parameters:

| | |
|----------------------|--|
| Volume (L* W* H) | Pro: 403×210×104mm Pro+: 449.5×210×104mm N30PL (water cooled) 382×91.5×102.9mm |
| Carton size (L* W*H) | 600x270x200mm |
| Weight | Pro: 8.5Kg (10Kg, including carton) Pro+:8.7kg (10.2Kg, including carton) |

Technical parameters:

| Model | N30Pro(Pro+) | N30i Pro (Pro+) |
|--------------------------------|-----------------|-----------------|
| Excitation mode | RF | |
| Radio frequency | 100MHz | |
| Cavity | Wave guide | |
| Wavelength | 10.6μm | 9.3μm |
| Average power | 35W | 17W |
| Laser output power range | 0-35W | 0-17W |
| M ² -beam quality | <1.1 | |
| Rise/ fall time | <80μs | |
| Modulation duty cycle range | 0%-100% | |
| Modulating frequency | 0 to 25KHz | |
| Output power stability | ≤±5% | |
| Beam Size (1/ e ²) | 1.8±0.2mm | 1.8±0.2mm |
| Beam divergence | 7.5±0.5mrad | |
| Ellipticity (full) | 0.9 to 1.1 | |
| Polarization | Linear > 100: 1 | |
| Wavelength range | 10.55-10.63μm | 9.27-9.33μm |
| Input voltage | 48VDC±2VDC | |
| Max. Working Current | 12A | |



3.4 Operation mode

N30Pro CO2 laser can be operated in CW mode and Gated CW mode.

CW mode

In CW mode, the RF power supply works in continuous mode and outputs continuous laser. TTL logic should stay at high level. In this mode, the laser outputs the rated maximum power, and the power cannot be adjusted.

Gated CW mode

Compared with CW mode, other command states are the same, except that TTL signal is changed into pulse waveform, so as to output pulse laser synchronized with it. (CW mode is actually a pulse waveform with 100% duty cycle). The peak power of laser pulse is the peak power in CW mode. It is suggested that the pulse width should not be less than 1 microsecond and the pulse repetition frequency should not be higher than 25kHz. There is no limit to the pulse duty cycle, and it can be from 0 to 100%.



3.5 Product structure

Schematic diagram of N30Pro structure

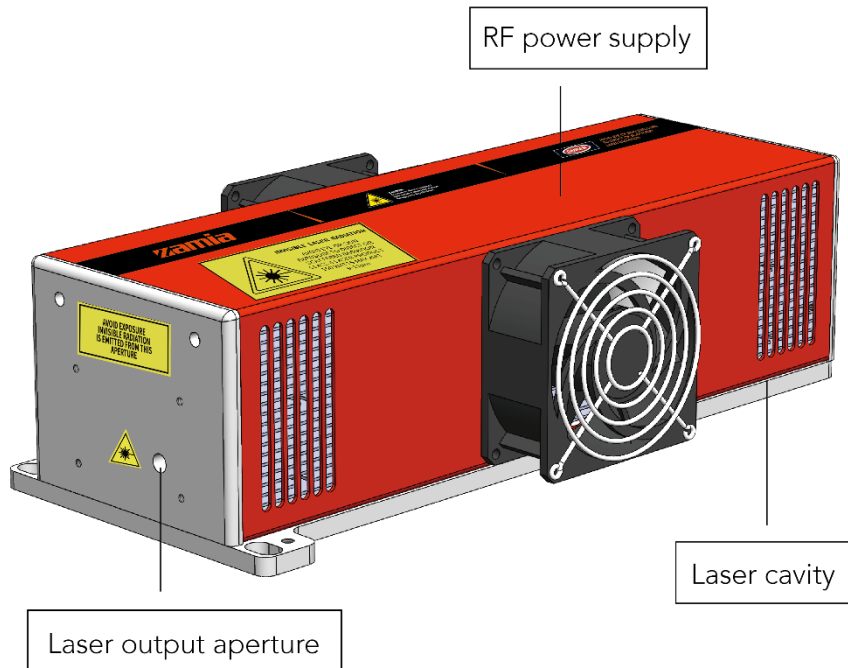

N30Pro laser is composed of a shell made of pure aluminum, which has two independent parts, the upper RF amplifier circuit and the lower laser resonator.

Laser cavity

The laser cavity is a hermetic metal structure with good thermal conductivity, ensuring good thermal stability of the laser.

There is a discharge electrode in the cavity, which excites the gas in the cavity and is the waveguide surface of the optical cavity.

The design of the laser cavity enables good spot mode output and stable power output of the laser, and reach its maximum output power.

Radio frequency (RF) amplifier

The RF amplifier provides pulsed RF power to the laser cavity to excite and ionize the working gas in the cavity. The switch and output power of laser tube can be controlled by external modulation signal.



Schematic diagram of N30Pro+

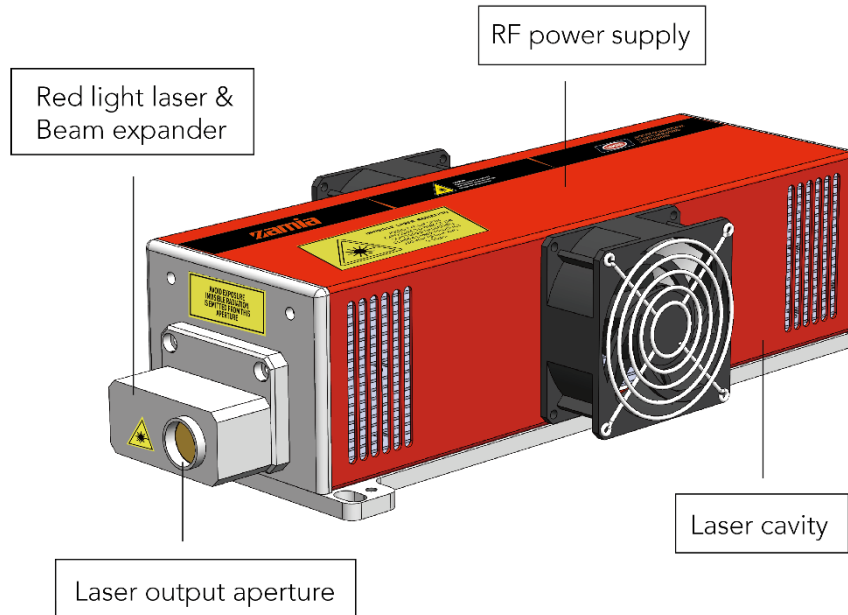

N30Pro+ is customizable and consumers can decide their own customized choice.

At present, N30Pro+ can be customized with the following options: **A. Coaxial red-light** **B. Beam expander:** 3/4/5 times optional. A and B can be freely selected or freely combined according to your demand.

Customizable part

1. Coaxial red-light

For N30Pro+ CO₂ laser, the third-generation coaxial red-light technology of SPT laser is available. The red-light module is designed to work with a 5V DC power supply, or it can be powered from the laser power supply (pin 11) or control card.

In the process of doing the optical path alignment, the transmission path of laser beam can be visually observed accurately, so that the optical path alignment is more accurate and convenient, making the whole process safe and efficient. During laser processing, it can help to preview and positioning.

2. Beam expander

N30Pro+ CO₂ laser can be optionally integrated with beam expanders, it is 3/4/5 times optional, which can be decided according to customers' overall optical path design. The laser with beam expander will be well tested before dispatch.

The beam expander makes the beam energy distribution of N30Pro+ more uniform in the machining process, which can effectively improve the machining accuracy and the assembly efficiency of the whole machine, the mounting time can be shorted up to more than 30%.



Chapter 4 Mounting

4.1 Outline & Mounting drawing

N30Pro CO2 laser:

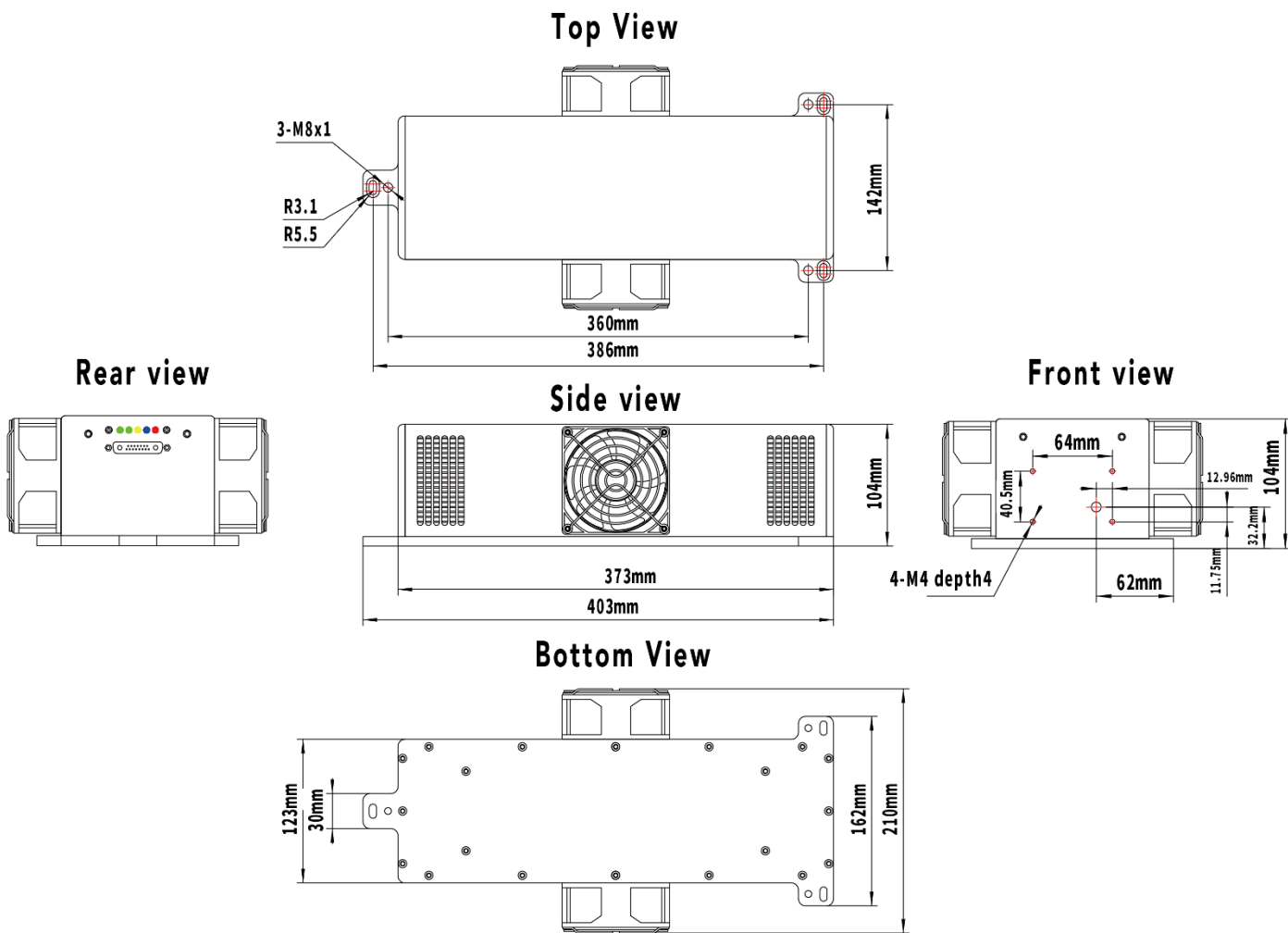



N30Pro+ CO2 laser:

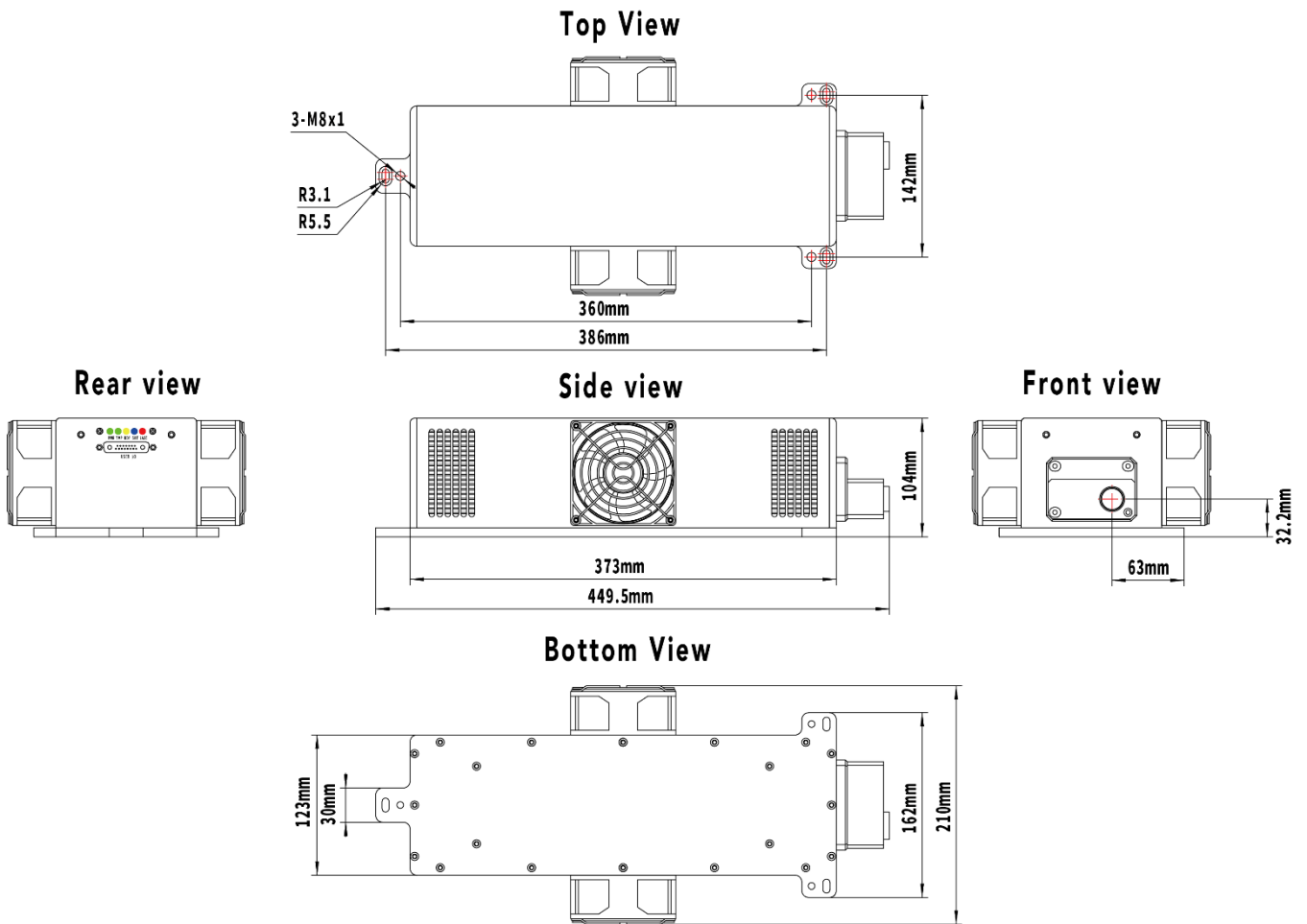

The laser beam of N30Pro laser exits through the output lens and connected to the optical path.

*** Do not connect the beam transmission equipment to the output window mounting bracket.**

4.2 Environmental conditions

Working environment requirements:

| | |
|-------------|-----------------------|
| Temperature | 0~45°C |
| Humidity | ≤95%, no condensation |
| Altitude | ≤2000m |



4.3 Wiring

When the N30Pro CO2 laser is used for the first time, it can be wired as shown in the figure below. Please refer to other chapters or paragraphs of this manual for detailed wiring instructions or requirements.

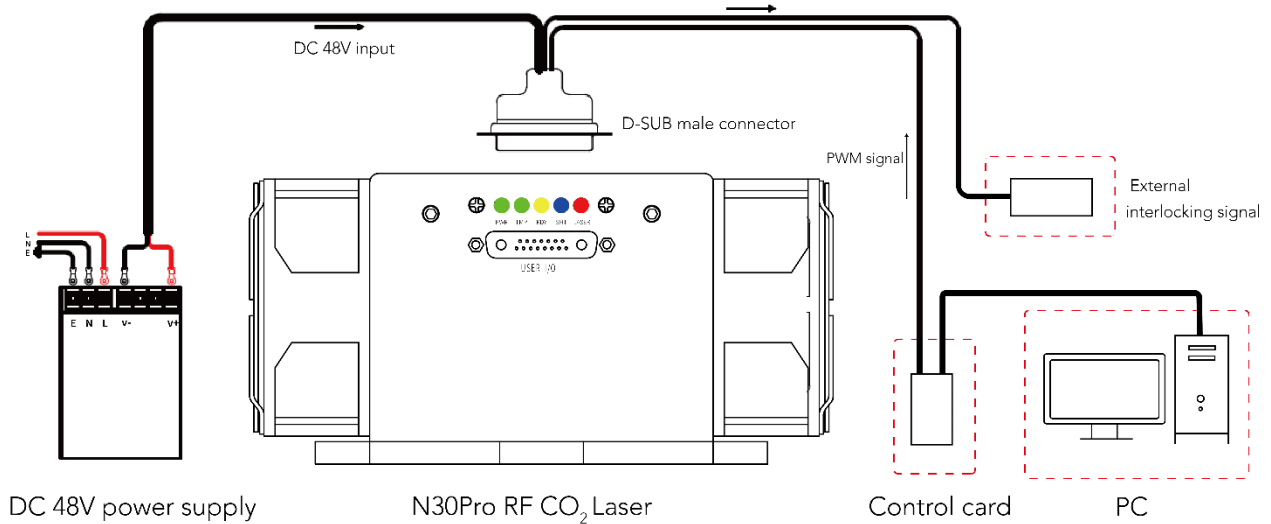

N30Pro wiring diagram

4.4 DC cable

N30Pro CO2 laser is powered by DC power supply. The DC cable used requires multi-strand winding wires, and the diameter of conductive core is larger than 3mm but smaller than 4mm. The insulation layer is reliable. The length of cable should not be longer than 4m. If the cable length is more than 4m, the voltage on the laser should be measured to ensure that the laser voltage is 48V.

4.5 Power supply system

The internal power supply system of the laser is high-frequency and high-power. Unqualified external power supply will lead to the damage of the internal power supply system of the laser. Please choose an external power supply that meets the requirements of the laser to ensure the normal operation of the laser.

Materials and tools required

1. DC power supply; 2. Cable; 3. Multimeter; 4. Oscilloscope; 5. Power cable.



Requirements and precautions for switch power supply

| | |
|------------------------|------------------|
| DC Output | 48VDC±2VC |
| Average output current | 12A |
| Peak current | 18A (for 1ms) |
| Ripple and noise | < 1% of the peak |

Suggestion: The power supply has the function of feedback control, which feeds back the voltage across the load to the power supply, and the power supply adjusts the output voltage in real time according to this value.

Attention during the laser operation:

1. The peak current required by the laser will directly affect the life of the power supply, and the DC power supply must have sufficient current and voltage instantaneous adjustment capability. When the laser stops working, the load current on the DC power supply suddenly drops from high current to almost zero. At this time, the output voltage of the DC power supply will suddenly rise. If the rising voltage exceeds 53V at this time, the power transistor in the RF amplifier in the laser will be damaged, resulting in the laser power drop or direct damage.

At the moment when the laser is turned on, there will be a high peak current requirement for the DC power supply. Under the condition of high load current, the output voltage of the DC power supply will drop, so this drop voltage should not be too much. If it is lower than 43V, the laser will work abnormally. The peak voltage duration of the DC power supply should not exceed 10µs, and the peak current duration that the DC power supply can provide should be greater than 1/3 of the starting pulse width of the laser (for example, if the pulse width is 300µs, the peak current duration should be greater than 100µs).

2. In order to ensure a good grounding, it is necessary to connect the negative pole of the DC power output to the ground. If the connecting cable between the laser head and the DC power supply exceeds 4 meters, the negative electrode of the power terminal on the laser head needs to be connected to the ground.

3. The laser has strict requirements on the input voltage fluctuation range. It is suggested to use an overvoltage protection circuit at the input end of the laser power supply to prevent the laser from being damaged due to excessive voltage fluctuation.

4. When connecting the laser power supply, connect it according to the label on the rear end of the laser. The position marked with "+" is the anode of the laser power



supply, which is connected with the anode output of the DC power supply. The position marked with "-" is the negative electrode of the laser power supply, which is connected with the negative output of the DC power supply. The maximum cable length required by the laser DC power supply is 4m. When connecting the cable, twist the cable between the DC power supply and the laser into a strand to reduce the mutual inductance between the ends.

5. The laser shell and DC power supply must be well grounded (ground). Ungrounding or poor grounding will lead to excessive noise, which will directly damage the laser.

6. When testing DC power supply, first measure it with multimeter (measuring voltage) and oscilloscope (measuring waveform size) under no-load condition, and then measure it with laser load (laser emitting light at full power) (with multimeter, oscilloscope and ammeter) to make sure that all indicators (voltage and current) of DC power supply meet the requirements of laser.

7. When connecting the power supply control interface of the laser, the connector should be completely inserted into the receptacle and fixed with screws to avoid the laser's being unable to work normally due to poor contact.

4.6 Cooling

The actual output optical power of the laser only accounts for about 10% of the RF power generated by the internal RF amplifier, and other power is basically converted into heat. Other electronic components inside the laser will generate a lot of heat when working, so the heat generated by the laser must be effectively conducted and transferred to avoid the damage of components inside the laser due to heat accumulation and high temperature. The laser takes away heat through the external cooling system provided by the user.

Heat dissipation by air cooling

Air-cooled heat dissipation is used by the N30Pro CO2 laser.

N30Pro CO2 laser comes with cooling fan, and the air outlet of the measuring surface of the fan should be left a free space of more than 6cm. If there is a cover outside the laser, a ventilation fan or air vent should be installed on the cover to ensure ventilation (Air flow of more than 6m³ per minute is required). If there is a lot of dust in the ambient air, a filter screen should be added to the hood, and a fan should be added to force the air to circulate. Besides, the filter screen should be cleaned regularly, otherwise it



will lead to poor heat dissipation of the laser, resulting in power attenuation and even damage to the laser! (If the environmental dust is really heavy, users are advised to choose water-cooled laser.)

Equipment ventilation examination: If the ventilation is sound, the temperature of the laser will rise by $\leq 20^{\circ}\text{C}$ after it is turned on.

The ambient temperature should be between 5°C and 40°C , and the maximum temperature of the laser surface should be below 60°C .

4.7 Control

The operation of the laser is controlled by external input control signals. It is necessary to provide the laser with work-enable signal, work-modulation signal and external safety locking device. By monitoring the output signal of the laser, the working state of the laser can be mastered.

Material and tool requirements:

| | |
|---------------------|---|
| TTL logic generator | Adjustable frequency and duty cycle |
| Oscilloscope | The oscilloscope bandwidth is determined according to the modulation frequency. |

External command signal requirements:

The control signal must be TTL logic.

The laser control port will absorb about 50mA of current when working, so the user must provide a control signal with sufficient driving capability so as to avoid the large change of control signal level caused by insufficient driving ability of the control signal. The high level of the control signal should not be much different from that of the on-load one. For example, the high level of the control signal is 5V in the on-load one, and it is better to keep it above 4.5V in the on-load one.

Note: N30Pro CO2 RF excited laser is set to provide a delay of 42 seconds by the internal chip when it leaves the factory. During this time, the chip provides a pre-ionization signal, which is used to keep the gas in the laser tube in pre-ionization state. When the delay time is up, only a small pulse signal needs to be input, and the laser will immediately generate laser light. If the customer doesn't need to delay, the external control board should provide a pre-ionization signal with a frequency of 5KHz and a pulse width of $1\mu\text{s}$ to the laser (as shown in the figure below). If there is no pre-ionization signal, the power output of the laser will be unstable and the effect will be impaired.

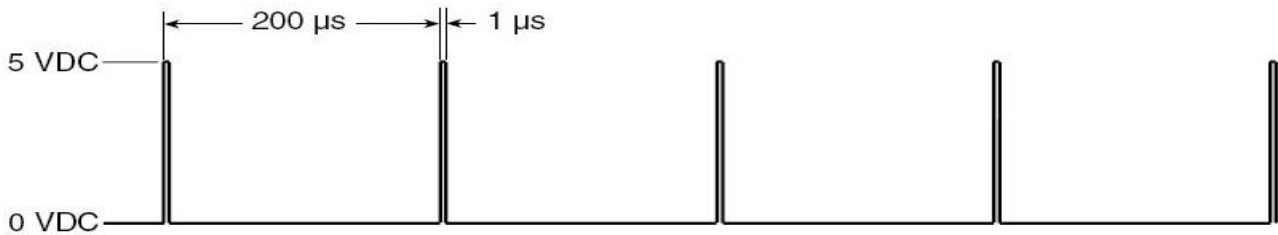

- **The state of the control terminal must always be under control.**

* After the control cable is connected to the laser, the signal of each control terminal pin should always be kept under control, so as to avoid the uncontrollable level signal of the control terminal pin due to being in a high-resistance suspended state.

- **The modulation signal must be a differential signal, otherwise the laser will be easily damaged by excessive common-mode interference voltage.**
- **The duty ratio of the modulated signal must be selected according to different laser models, and the high-level pulse width should be between 3μs and 1000 μs.**
- **The modulation signal should be a pure NNL level signal. Excessive interference (voltage fluctuation), voltage jump and voltage spike in the control signal will cause damage to the internal control circuit board and RF amplifier of the laser.**

* In order to prevent the laser control signal from being disturbed, please keep the wiring of the control cable away from high voltage, high current, electrical appliances and cables with electromagnetic radiation.

4.8 Protection for optical path

The output lens of the laser is very sensitive, and the particles and moisture attached to the lens will cause fatal damage to the lens of the laser. Good external sealing for optical path can prolong the service life of the laser and reduce the failure rate of the laser.

Problems that may occur in the front output window during the use of the laser:

If the environment in which the laser works is dusty, or there are oily and colloidal particles, the lens will be polluted (by dust, oil, water, etc.). Under the action of high-energy density laser, the coating on the lens surface will be burned, resulting in the decrease of laser output power and the deterioration of light spot output mode.

If the material processed by the laser contains a plane (metal, etc.) with high reflectivity to the wavelength of 10.6 μm , the front output window of the laser will be broken down by the retroreflection energy due to the retroreflection. If the mesa of the user's laser processing platform is a metal plate (aluminum plate, etc.), the front output window of the laser will burn down due to back-reflection.

To avoid the above possible situations, the following steps need to be done:

If there are many attached pollutants such as dust, oily particles, colloidal particles, etc. in the environment that the equipment works, the front output window of the laser should be sealed.

It is suggested to install Brewster window at the front output window of the laser for sealing. The Brewster window can effectively prevent the adhesive particles in the environment from directly adhering to the output window of the laser, and effectively protect the output window of the laser from dust.

If the processed material contains planes of metal and other materials with high reflectivity to the laser wavelength, the backward reflection isolator should be installed to avoid the damage caused by backward reflection to the front output window of the laser. If the laser processing table is a metal flat plate, a honeycomb processing table instead of a flat processing table is used to avoid back-reflection.

4.9 Fixing

The laser can be mounted at any angle. If the laser is installed with the output window facing up, the user must pay attention to the dust protection of the laser output window to avoid the lens burning due to dust particles falling on the output window.

During the installation of the laser, the user should avoid the external strong distortion of the laser cavity. Long-term strong distortion will deform the laser cavity, which will lead to the detuning of the laser, and then lead to the power reduction of the laser, the deterioration of the spot pattern or even the absence of light.



Chapter 5 Control and Operation

5.1 Operation flow chart

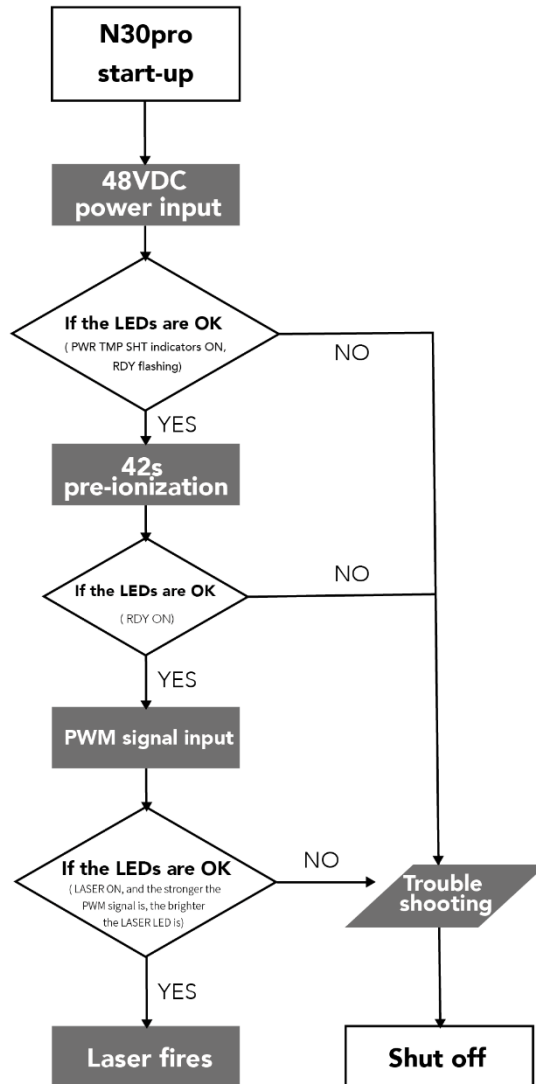

N30Pro operation flow chart

Attention: Before cutting off the power of machine, please don't cut off the power supply of the fan at once, but keep the fan working for 5 minutes more to cool down the laser when the N30Pro stops firing. The laser with high temperature can absorb a lot of dust, which will affect the heat-dissipation effect of the laser.



5.2 Preparation for operation

Only need to provide 48VDC and control signal to make the laser work.

Tools required:

1. DC power supply (48V, power over 600W)
2. Fixed bracket (firm and elastic)
3. TTL logic generator (modulation frequency: 0 ~ 25 kHz, duty cycle: 0 ~ 100% adjustable)

5.3 Control Terminal

N30Pro CO2 laser is controlled by external modulation signals, and the types of signals it receives and outputs are TTL logic. The ON/OFF and laser output power can be controlled through the ON/OFF and duty cycle of modulation signal. At the same time, there are abundant detection and feedback signal interfaces on the laser, which is convenient for operators to detect and tell the working state of the laser. Differential linear driving module to provide driving signal for laser is required, also the TTL logic generator and other control and detection devices.

Note: The waveform shown in the figure below is a typical 0-5V TTL logic with adjustable duty cycle (or pulse width) and frequency:

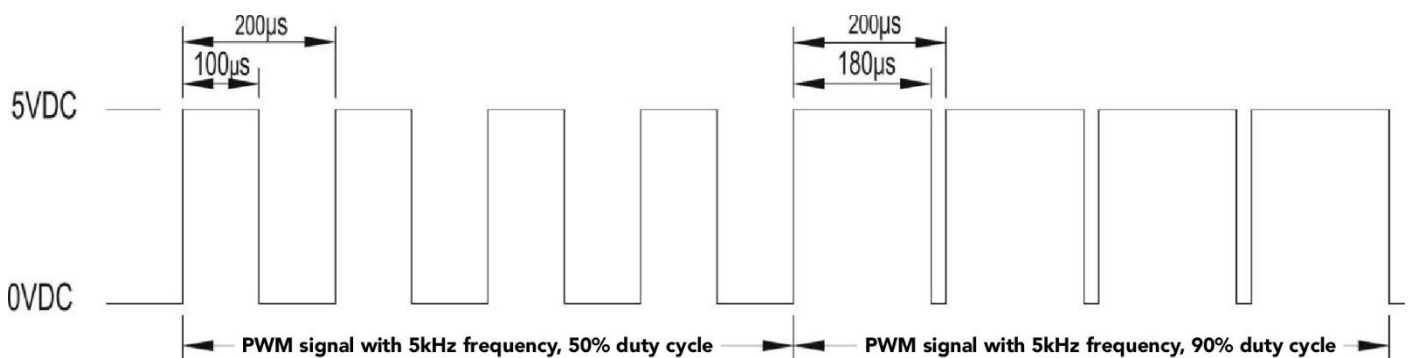



5.4 Power input & D-SUB connector

N30Pro CO2 laser is easy to be operated, please refer to the definition of D-SUB interface to control and test.

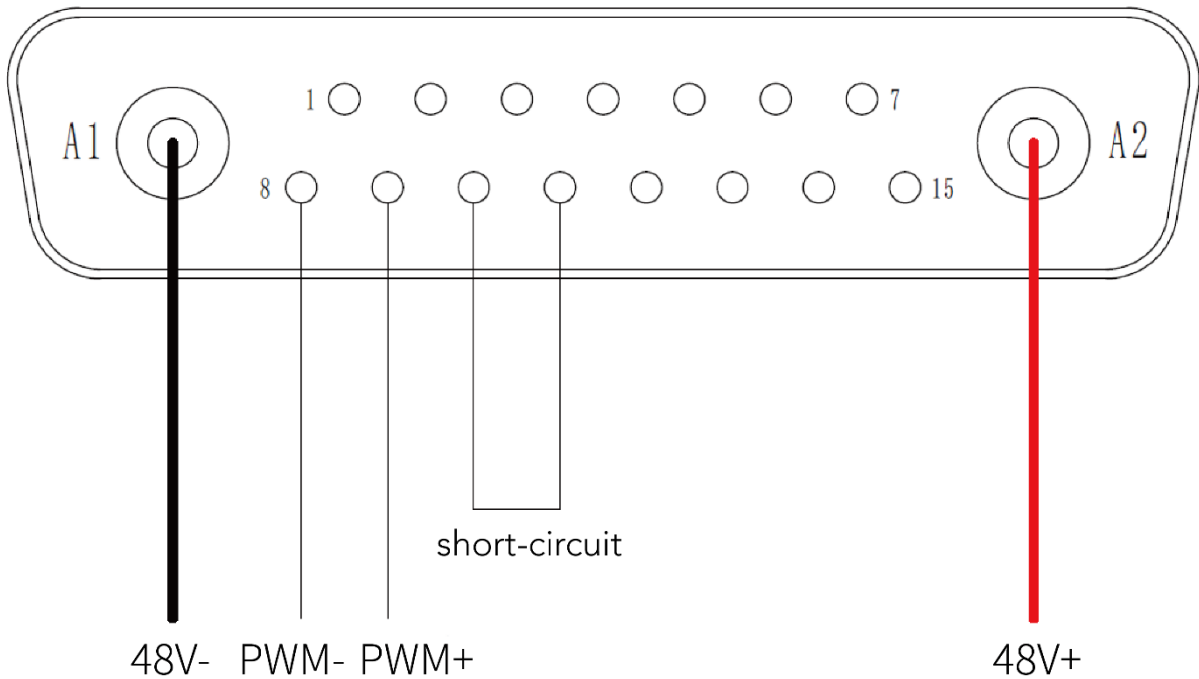

N30Pro simple wiring diagram

* For more wiring methods of other functions, please refer to the definition of the connector.

D-SUB connector:

| PIN | Signal description | Explanation |
|-----|------------------------|---|
| A1 | DC INPUT | DC 48V- |
| A2 | DC INPUT | DC 48V+ |
| 1 | GND | Logic ground |
| 2 | LED-PWR signal output | TTL logic output, output is asserted when 48VDC input value is normal |
| 3 | LED-TEMP signal output | TTL logic output, output is asserted when temperature is below the 60°C housing temperature warning level |
| 4 | LED-RDY signal output | Output is asserted when no faults are detected from the laser. |



| | | |
|----|---|--|
| 5 | LED-SHT signal output | Signal output of the state of laser being enabled |
| 6 | LED-LASE signal output | Signal output of laser's firing state |
| 7 | GND | Logic ground |
| 8 | GND | Logic ground |
| 9 | PWM signal input TTL logic input; 1=RF ON, 0=RF OFF; 1kΩ impedance | The pin10 should be set to logic high first, and then set pin 9 to logic high to turn on the laser |
| 10 | Control Enable TTL logic input; 1= laser control enabled, 0= laser control disabled. | After being set to logic high, the laser is enabled. And then set pin 9 to logic high to make laser fire. |
| 11 | VCC output Output voltage+5±0.5 VDC, output current: 250mA | It can be used to power an external circuit, and can also be used as enable logic when being short-circuited with pin10. |
| 12 | DC15V Output voltage+15±0.5 VDC, output current: 250mA | Used for RF test. If the voltage is not within +15±0.5 VDC, the laser should be returned to the factory for repair. It can also serve as power supply for external circuits. |
| 13 | FANPWM | PWM signal output for fan |
| 14 | NTC | 10K NTC thermistor is used to detect the temperature and voltage output of power amplifier. The higher the temperature, the lower the output voltage. |
| 15 | GND | Logic ground |

Note:

1. When the laser firing, the power meter or other light-blocking objects must be mounted in front of the laser head to avoid accidental injury.
2. Please look up in the manual carefully for operation requirements before operating and testing the laser.



5.5 Indicators

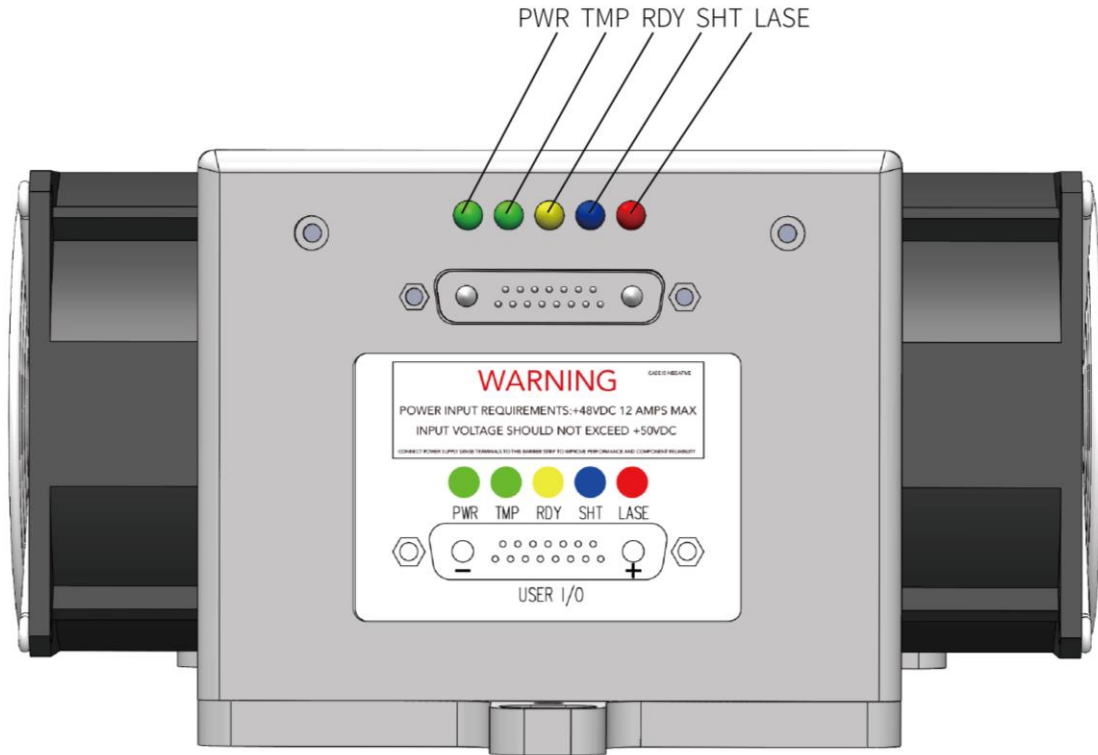

| Indicator LED | Color | Definition |
|---------------|--------|--|
| PWR | Green | Always on: the input voltage is normal, no fault. Normally off: no power input. Flashing once, off for 1s: the input voltage is less than 46V. Blinking twice, off for 1s: the input voltage is more than 51V. |
| TMP | Green | Always on: the laser temperature is normal, no fault. Flashing once, off for 1s: the NTC temperature is higher than 90°C. Flashing twice, off for 1s: the NTC temperature is lower than 5°C. Flashing for 3 times, off for 1s: the cavity temperature detected by the temperature chip is higher than 70°C. |
| RDY | Yellow | Continuous flashing in pre-ionization period. Always on: the laser is ready, no fault. Normally off: the laser input voltage is faulty or the temperature is faulty, or the power is not turned on or the enable signal is not given. Flashing once, off for 1s: RF feedback failure. |



| | | |
|------|------|---|
| SHT | Blue | Normally off: no enable signal; Always on: there is enable signal. |
| LASE | Red | Off: no PWM signal input, and the brightness of the indicator changes with the PWM signal. The stronger the signal is, the brighter it will be. |

5.6 Start and pulse operation

Before the laser is put into operation, please reconfirm the following items:

1. The output voltage of DC power supply has modulated to 48V.
2. TTL control signal meets the working requirements of laser.
3. The power terminal and control port are in good contact.
4. The dust plug at the laser output window has been removed.
5. The laser protection of personnel in the laser operation area is OK and that of laser equipment is OK.

After correctly applying DC 48V voltage to N30Pro CO2 laser, confirm that the fan rotates normally. Wait for 42 seconds (for running without delay, the control card must be able to provide a pre-ionization signal), start the PWM signal, and immediately output the laser. The output laser power will increase with the increase of the duty cycle of the PWM signal.

When N30Pro CO2 laser works in an environment of high humidity, it's necessary to observe the surface and window lens of the laser to see if there is dew condensation. If so, the chiller should be shut down at the same time if the laser is water-cooled. If the laser is cooled by air, it means that the ambient humidity is too high. If necessary, please install an air conditioner to reduce the ambient humidity. When the laser does not work for long time, please stop the power supply to the laser and the laser cooling system. When the laser is running in the case of heavy dust, it is necessary to conduct dust prevention. The optical path should be sealed at the joint of each interface with rubber rings.



5.7 Cautions for Safe Laser Operation

This product is Class 4 laser products, which can cause dangerous diffuse reflection, which may lead to personal injury or fire. Be careful when using it!

Please take safety precautions in strict accordance with this manual.

Chapter 6 Technical Reference

6.1 Laser Resonator

N30Pro is a diffusion air-cooled waveguide CO₂ laser excited by RF. The RF power supply works as the pump source to discharge the laser cavity. There are four adjustable mirrors (we call them optical resonators) mounted at both ends of the resonator, and it consists of three total reflection mirrors and one output lens with transmittance. The four optics form a folded "Z" optical resonator. There is a plasma tube excited by radio frequency between the optical resonators. The plasma tube consists of a discharge plate and a ceramic plate, and its mechanical structure is shown in the following figure. The discharge plate is processed into a specific shape, so that the resonant frequency of the cavity is 100MHz to match the working frequency of the RF power supply. A Z-shaped light-guiding groove matched with the optical resonator is processed on the ceramic plate.

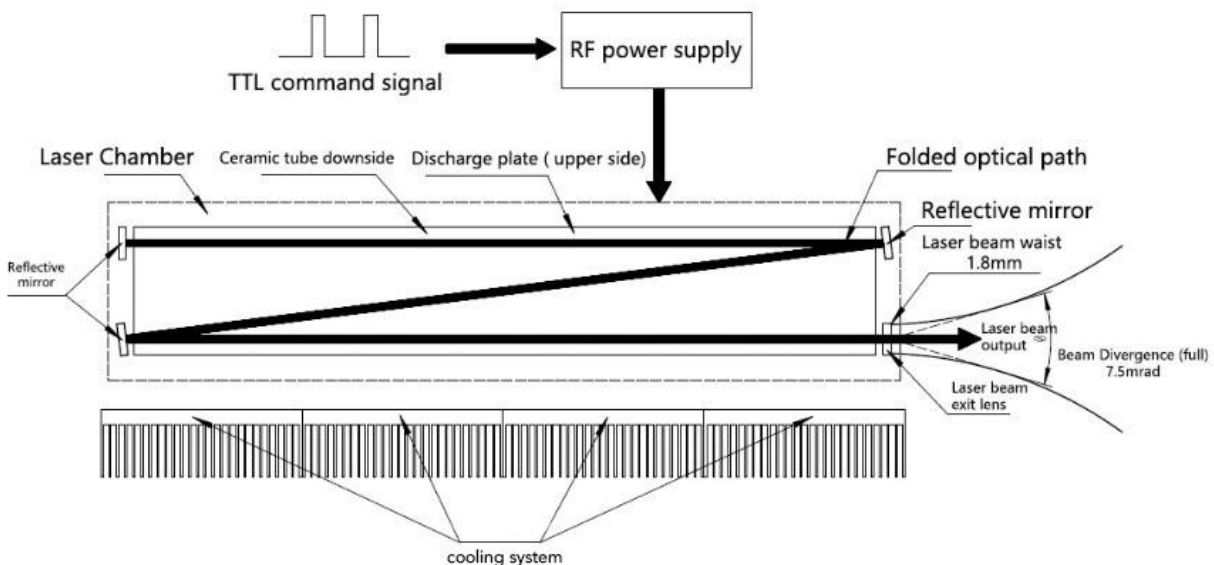

6.2 Heat dissipation

In the laser operation, the RF power ionizes CO₂ to generate laser, and at the same time, about 80% of RF power turned into heat and accumulates in the discharge area. The waste heat accumulated in the discharge area is conducted to the outer wall of the laser through all four metal surfaces, and then taken away by the external cooling system.



6.3 Laser beam

The laser beam shape is very close to round at the laser beam exit, and becomes circular at the far field (0.3m or more away from the laser), with a near-Gaussian profile. The beam mode quality (M^2) generated by the internal structure of the resonator and the optics is less than 1.2. As shown in the figure below, the beam waist diameter at the output exit is 1.8mm, and the full-angle divergence is 7.5mrad (full-angle divergence of 7.5mrad means that the beam diameter increases by 7.5mm every one-meter distance away).

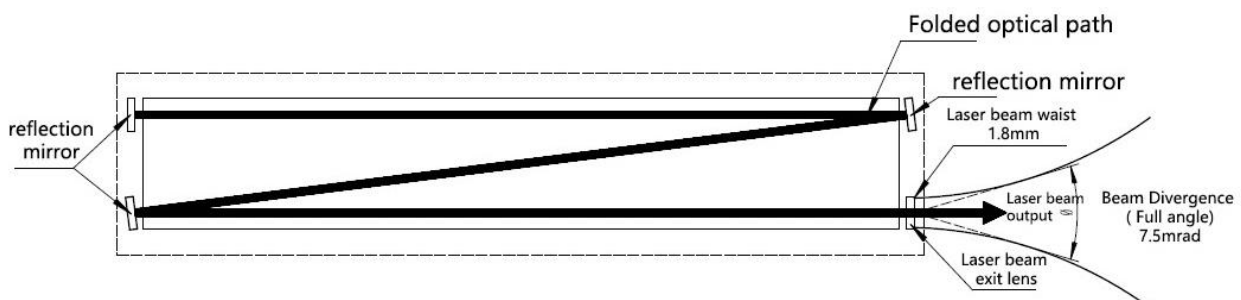

6.4 Backward reflection beam isolation principle

When N30Pro CO₂ laser is applied to the processing of highly-reflective materials, it is necessary to mount a retroreflected beam isolator in the optical path. The design principle is as follows: the laser beam passes an optical component that is completely transparent to P-polarized light and completely reflects S-polarized light, such as a Brewster window, and then reaches a 45-degree mounted phase delay device, such as a 45-degree phase delay speculum, and passes through a focusing lens in the end to reach the process material surface. After being reflected by the highly-reflective material, P light passes the phase delay speculum for two times and turns into S light. When the S light turned from P light reaches the Brewster window, it will be totally reflected and cannot go back to the laser. Protects the laser from being damaged by the reflected laser beam. One-way optical transmission device composed of Brewster window and 45-degree phase retardation lens is one kind of beam isolator.

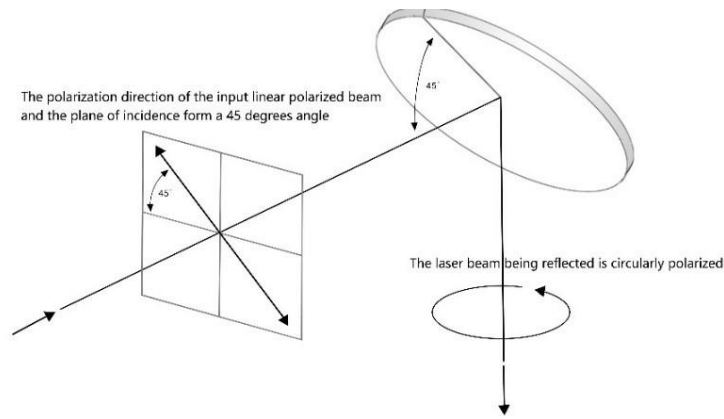

Schematic diagram of 45 phase delay mirror

6.5 Construction of external optical path and optics protection

Generally, there are two common optical path designs, one is for laser cutting machine and the other is on the laser marking machine. For the optical path of laser cutting machine, the laser beam being reflected by two pieces movable 45-degree mounted mirrors and then focused by a lens to process on material. In the laser marking machine optical path (post-focusing), the laser beam firstly being expanded by the beam expander, then reflected by galvanometers, and being focused in the end by a F-theta lens to achieve precise and rapid processing in a small working area.

A good exhaust device is required in the processing area in case the lens polluted by the waste gas. From the laser beam exit to the focusing lens, a reliable optical path sealing device should be mounted. If necessary, blowing air (clean air or nitrogen) in the sealed optical path.

During mounting and tuning of optics in external optical path, the optics surface should not be polluted, and the lens should not bear excessive mechanical stress.

6.6 RF power supply

N30Pro laser generates a 100MHz RF signal by a crystal oscillator, and a high-power RF output is generated through a power amplifier circuit. The RF power supply is powered by 48V DC power supply, and the output power is controlled by PWM signal.

The RF power supply can indicate the state of laser, and the output signal is provided to the external indicating device through the output interface (D-SUB) to tell the working state of the laser, signals like working state, temperature, power supply voltage detection, etc.



6.7 Modulation signal & pulse width modulation

The laser receives the external PWM signal to modulates the output power of the laser. Obtain the corresponding laser pulse output through the pulse width and frequency of the output signal. For N30Pro CO2 laser, the maximum duty cycle is 100%. The relationship between Q-switching frequency and pulse width is as follows:

$$W = \frac{\text{duty cycle} * 1000}{Q}$$

Formula description:

| | |
|---|--|
| W | The modulation pulse width, in μs |
| Q | Modulation frequency, in kHz |

For example, if the frequency is 5KHz and the duty cycle is 60%, according to the formula above, $W = 60\% * 1000/5 = 120\mu\text{s}$.

6.8 Marking & Engraving

Input PWM signal, the laser pulse width and frequency can be modulated when modulating the laser output power. In the processing of some materials, certain frequency and pulse width can achieve better processing effect.

Recommend to operate the laser with PWM signal at duty cycle of 95% at most, because the laser output power hardly increases when the duty cycle is between 95% and 100% PWM (as is shown in the figure below). When the power is close to saturation, the PWM duty cycle will present a nonlinear power function, and it will be flat when the duty cycle is about 95%. If you continue to use 100% duty cycle, the power consumption will increase and the heat load will increase by 5%.

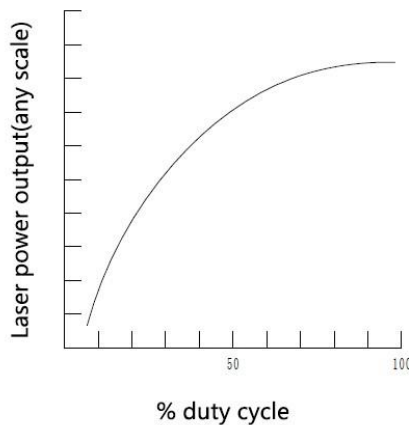

Chapter 7 Maintenance

If the optics on the laser are damaged, please contact the after-sales service of SPT Laser Company.

N30Pro CO2 laser is maintenance-free, sealed-off, and only the optics need to be checked and cleaned regularly. Common contaminants of laser lens and optical path lens are dust, cotton wool, etc. These pollutants can cause laser beam absorption and laser scattering, and the optics may be permanently damaged in extreme cases. If improperly disassembled, the laser may be permanently damaged.

Regular maintenance

Please turn off the equipment and disconnect the power supply first. It is recommended to clean the laser housing with wet cloth, and do not let water enter the laser to avoid damage to the laser.

Maintenance of laser lens and optical path lens

Please turn off the equipment and disconnect the power supply, seal the optical path of the laser device, take out the lens with gloves on, and put it on a non-woven cloth or a special lens-wiping cloth. When wiping the lens, dip the lens-wiping cloth in alcohol or acetone and can only move in one direction on the lens, and the used lens wiping cloth cannot be used for second time. If the laser operating in a dusty environment, please use filtered clean air or high-purity nitrogen to blow and clean the surface.

Maintenance material requirements:

| Material | Requirements |
|----------|---------------------|
| Gloves | Dust-free |
| Nitrogen | >99.9% |
| Alcohol | Spectral pure level |
| Acetone | Spectral pure level |

Chapter 8 Questions & Answers

1. Why does the laser need to wait for a period of time to give a signal after each power-on?

A: In order to prolong the service life of N30Pro CO2 laser, the internal chip is set with a delay of 42 seconds. During the delay period, the working gas in the cavity is pre-ionized in advance to prevent the RF power supply from being overloaded instantly.

2. What should be paid attention to in the process of laser storage and transportation?

A: Seal the laser output window to prevent possible contaminants attached onto it. Handle with care to avoid accidental impact on the laser.

3. What are the requirements of the environment for laser using?

A: The ambient temperature should be kept at 5°C ~ 40°C. When the laser has no external equipment for dust protection, a high dust degree will cause the light-emitting window of the laser to burn out. When the ambient humidity is high, the laser will be dewed; the pH of the environment shall remain neutral.

4. If the lens of the laser output window is contaminated, what should I do about it? Can I wipe it with a cotton swab?

A: Don't wipe it with a cotton swab, the lens can be damaged. If a few particles are attached to the front lens and the lens coating has not been burned, recommend to blow it with nitrogen with purity of 99.95%.

5. If the laser beam size is known, how to decide the size of the optics in the external optical path?

A: The size of the optics in the external optical path shall be 1.5~2 times of the actual laser beam size.



6. The power at the laser exit aperture is normal, but the power at processing terminal is low, what would be the reasons?

A: Generally, it is caused by high power loss in the external optical path. The following points should be checked:

1. If the size of the optics in external optical path and the clear aperture are big enough;
2. If the optics in the external optical path is qualified (the deterioration of a single optics cannot be more than 3%);
3. If the optics in the external optical path is contaminated or damaged;
4. If the external optical path is correctly aligned.

7. What should be done when the laser power is low or unstable during operation?

A: The following points should be checked:

1. Check if the DC power supply voltage of the laser is normal with a multimeter;
2. Check if the control signal to the laser is normal with an oscilloscope.

8. There are many sealing labels attached to the exterior of the laser. What is the function of them?

A: If the sealing label is damaged, the warranty of laser will be expired.