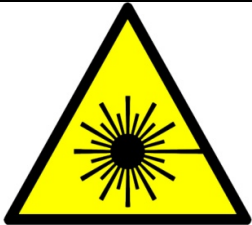
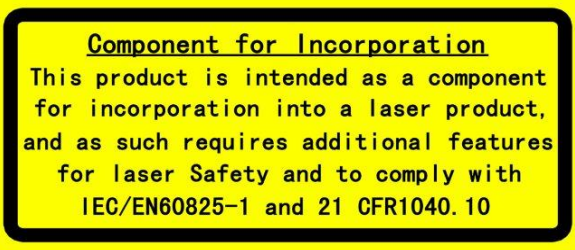

Safety

Please read this user manual carefully before operating the YDFLP fiber laser. It provides essential information regarding safety, product operation, and other necessary reference information. For the purpose of safety operation and maximizing the performance of the fiber laser, please strictly follow the safety notifications as below:

- Make sure the +24VDC power supply is connected in the correct way. Inappropriate connection might spoil the product.
- You can't open the cover of this product without the permission of JPT. It might cause safety issues and invalidate the warranty.
- Please wear laser goggle, as shown in Fig. 1, all the time during the operation. This laser module carry a Class 4 Laser rating it emits invisible laser radiation with a rated average output power of over 10W and rated peak power of over 7kW. Contact with direct or scattered laser radiation will cause permanent damage to the eyes, burn human tissue and start fires.
- Attention: Even at 0% power setting, the average output power is still about 90mW.

Table 1 Safety Labels

Symbols	Information
	Laser Warning Triangle -Label of laser emission (Attached near the output fiber)
	Component for Incorporation labeling (Attached at the upper cover of this product)

<p>Wavelength 1040-1200nm Pulsed Output: Max Pulse Energy <2.0mj Repetition Frequency 20-500kHz Pulse duration >10ns Max Average Power <50W CW Output Power <50W IEC/EN 60825-1:2001</p>	<p>Safety Information (Attached at the upper cover of this product)</p>
<p>CAUTION-CLASS 4 INVISIBLE LASER RADIATION WHEN OPEN AVOID EYE OR SKIN EXPOSURE TO DIRECT OR SCATTERED RADIATION</p>	<p>Safety Warning (Attached on the output fiber isolator & collimator)</p>



Figure 1 Laser Safety Goggle

Contents

SAFETY	1
CONTENTS	3
1. PRODUCT TOUR	4
1.1 PRODUCT DESCRIPTION.....	4
1.2 PACKAGING LIST.....	5
1.3 OPERATION CONDITIONS AND SAFETY INSTRUCTIONS.....	5
1.4 YDFLP PRODUCT SERIES NAMING CONVENTION.....	6
1.5 TECHNICAL SPECIFICATIONS.....	7
TABLE 4 SPECIFICATIONS OF THE YDFLP-M6+ FIBER LASER.....	7
2. INSTALLATION	12
2.1 DIMENSIONS.....	12
3. CONTROL AND MONITORING INTERFACES	14
3.1 CONTROL INTERFACE.....	14
3.2 PULSE WIDTH CONTROL.....	16
4. OPERATION PROCEDURE	19
4.1 PREPARATORY EXAMINATION OF THE PRODUCT.....	19
4.2 OPERATION PROCEDURE.....	19
4.3 PRECAUTIONS DURING THE LASER OPERATION.....	19
5. MAINTENANCE, CUSTOMER SERVICE AND REPAIR	20
5.1 STANDARD WARRANTY.....	20
5.2 WARRANTY LIMITATION.....	20
5.3 SERVICE AND MAINTENANCE.....	20

1. Product Tour

1.1 Product Description

The JPT YDFLP pulsed fiber laser adopts the MOPA (Master Oscillator Power Amplifier) configuration, in which a semiconductor laser diode serves as the master oscillator and the fiber amplifiers boost the output power. For this MOPA pulsed fiber laser, the pulse width and pulse repetition frequency are able to be adjusted independently. By changing the pulse width of the fiber laser, the peak power of this MOPA fiber laser can be maintained at the same level for different pulse repetition frequency. This feature makes the product an idea laser source for various industrial applications.

The MOPA fiber lasers get pumps through fiber couplers, which embed them with higher slope efficiency compared to conventional solid state lasers. The fiber laser is more compact and easy to carry, because it only uses three cooling fans to effectively remove the heat generated inside the chamber. Besides, the all fiber based laser cavity enables higher beam quality of the laser output.

JPT's MOPA fiber laser adopts the standard DB25 interface, and it is power supplied with 24V/8A DC power supply, which makes it a good compatibility. A photograph of a typical JPT MOPA fiber laser is as shown in Figure 2.



Figure 2 JPT's MOPA Fiber Laser

1.2 Packaging List

Table 2 Packaging List of YDFLP

Item	Quantity	Comments
Fiber Laser	1	
24V Power Cable	1	
USB Data Line(GUI)	1	
Isolator Dust Cap	1	
Testing Report	1	
Specification List	1	
Precautions for Usage	1	

1.3 Operation conditions and safety instructions

In order to maintain good performance and reliability of this product, please always operate the laser under normal conditions as below:

- 1) This fiber laser shall be operated with 24V/8A DC power supply; **wrong connection will lead the fiber laser can't work**
- 2) There should be 10-cm-wide air gaps in front and behind the fiber laser chamber, and the air flow direction should be the same with the fiber laser module and the rest of the whole system; **Short Ventilation distance and wrong air flow direction will lead the fiber laser can't work.**
- 3) The operating temperature should be 0~40°C; the fiber laser will alarm internal if the temperature above 40°C; it's a protection action in order to insure the long time operational reliability.
- 4) Please keep the laser module clean during the operation, especially for the fiber pigtail and output isolator; please remember cover up isolator exit during unworking time.
- 5) Power off the product before installing or uninstalling this fiber laser;
- 6) Never look at the fiber laser head, and please wear laser goggle when operate this fiber laser;
- 7) The YDFLP-M6+ contains 16 pulse width to choose: 1ns,2ns,4ns,6ns,9ns,13ns,20ns,30ns , 45ns,55ns,60ns,80ns,100ns,150ns,200ns,250ns.If you need other pulse width, please contact us for customization.

1.4 YDFLP Product Series Naming Convention

Table 3 Naming Convention for Pulsed Fiber Laser

YDFLP-XX-XX-X-X

1 2 3 4 5

1. Product name
2. Average Output power
3. Product Series
4. Optical Fiber Types
5. Product Types

1. Product name.	YDFLP Ytterbium Doped Fiber Laser Pulse		
2. Average Output power (optional).	20W		
	30W		
	60W/70W/100W/120W/150W		
3. Product Series (optional).	Pulse width adjustable	M Series	M1(+)
			M6(+)
		LM1 Series	large pulse width
	Pulse width fixed	LP series	
4. Optical Fiber Types	S		Single mode
	L		Low mode
	H		High mode
5. Customized	Without:Standard product;		R:Built-in red pilot laser

Table 3 Naming Convention for Pulsed Fiber Laser

For example:

YDFLP- 20—M1+—S: Means this is a standard product of M1+ using single mode type of optical fiber with the nominal output power @ 20W.

YDFLP- 30—M1+—L—R: Means this is a customized product of M1+ using low mode type of optical fiber with the nominal output power @ 30W,Integrated built-in red pilot laser.

1.5 Technical Specifications

Table 4 Specifications of the YDFLP-M6+ fiber laser

Laser Type	Unit	MOPA
Product Model		YDFLP-20-M6+-S
Average Output Power	W	20
M2		< 1.3
Output Fiber Length	m	2m (Customizable)
Pulse Energy	mJ	0.5
Full Power Frequency Range	kHz	40-2000
Adjustable Frequency Range	kHz	1-2000
Pulse Width Range	ns	1-250
Output Power Stability	%	< 5
Cooling Method		Air Cooling
Supply Voltage	V	24
Current consumption	A	< 8
Environmental Supply Current	A	> 8
Power Consumption (20 °C)	W	<120
Center Wavelength	nm	1064
FWHM (nm) @3dB	nm	< 15
Polarization		Random
Anti-Reflection Protection		YES
Output Beam Diameter (mm)	mm	7
Power Range	%	0 ~ 100
Operation Temperature Range	°C	0 ~ 40
Storage Temperature Range	°C	-10 ~ 60
Dimension	cm	315*220*99
Weight	kg	Net:8.5 G.W.:9.75

Table 5 YDFLP-M6+ Threshold Frequency

	YDFLP-20-M6+-S
Pulse Width (ns)	Threshold Frequency (KHz)
1	1600
2	850
4	500
6	320
9	250
13	170
20	115
30	90
45	75
55	65
60	65
80	60
100	55
150	45
200	45
250	40

For safety concern, when pulse width $\geq 80\text{ns}$, frequency $\geq 400\text{ kHz}$, input and output frequency is as shown in the figure below:

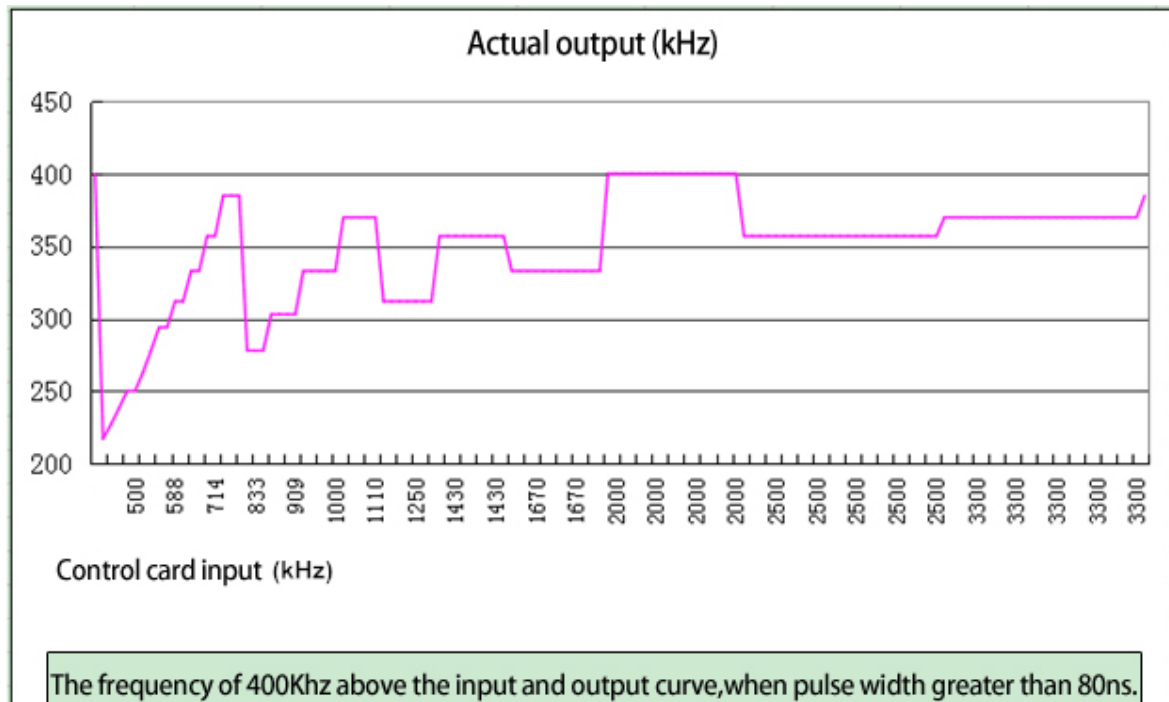

*Above the cut-off Frequency value is the fiber laser full power output range, oppositely, below the cut-off frequency value is the cut-off power output range. That means the fiber laser will reduce the output power to protect the machine when below the cut-off frequency value. Below is the charts that showed the change between frequency and output :

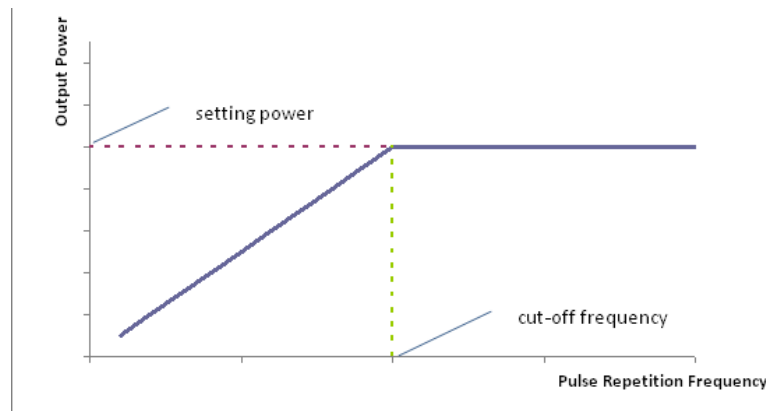

Figure 3 Cut-off Frequency & Output power relationship charts

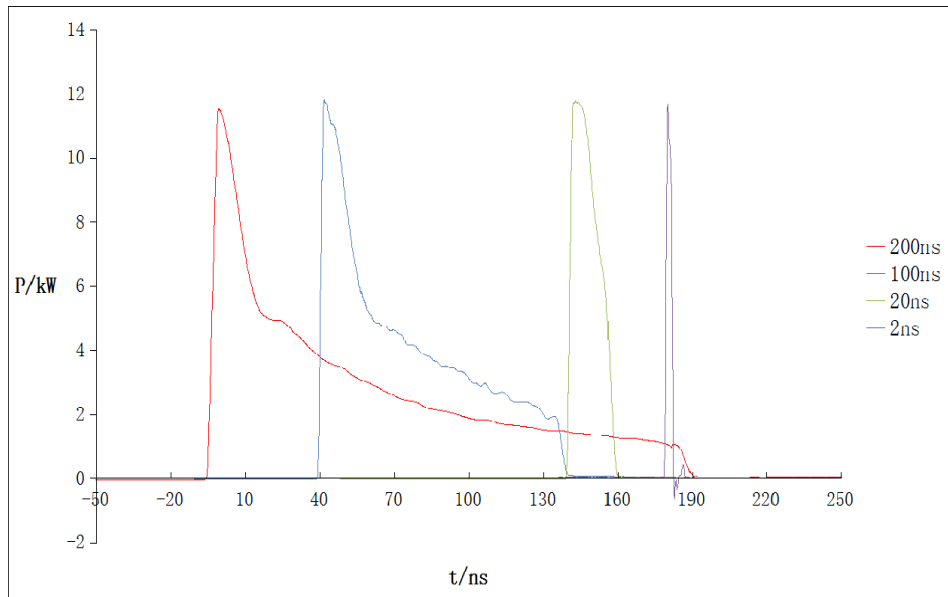

Figure 4 Waveform curve of M6+-S

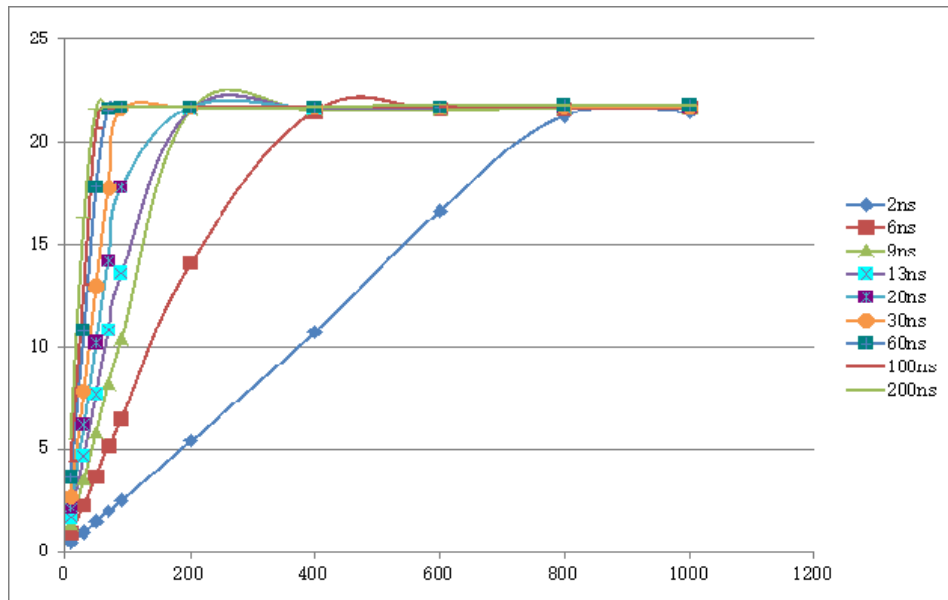

Figure 5 The actual output power curve of M6+ full loaded at different pulse width and frequency

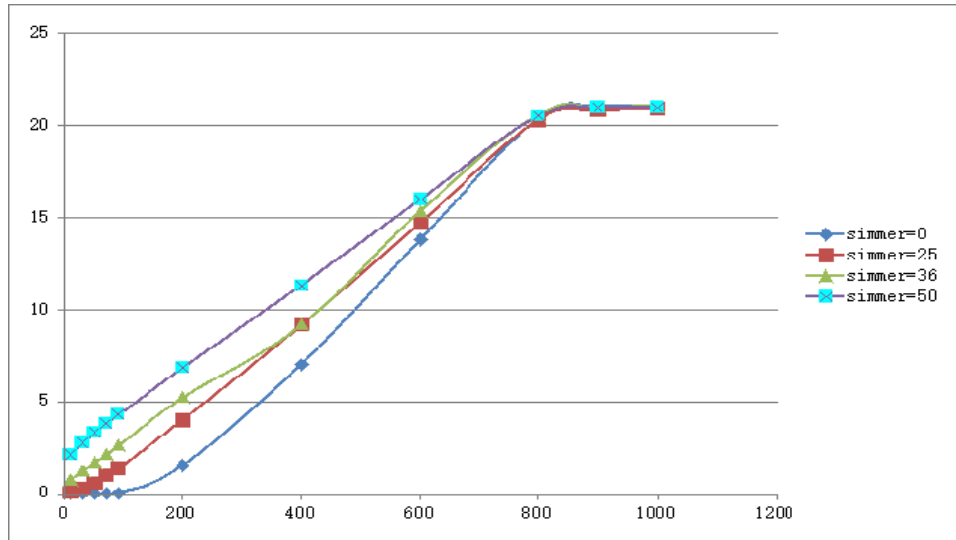

Figure 6 The actual power curve of M6+@ 2ns at different simmer value and frequency

※ M6+ can use GUI to adjust the Class II simmer value to achieve customer required effect. The changes of simmer value will influence the output power under the same parameters. Figure 6 shows the impact of simmer value.

2. Installation

2.1 Dimensions

1. Dimension of main body

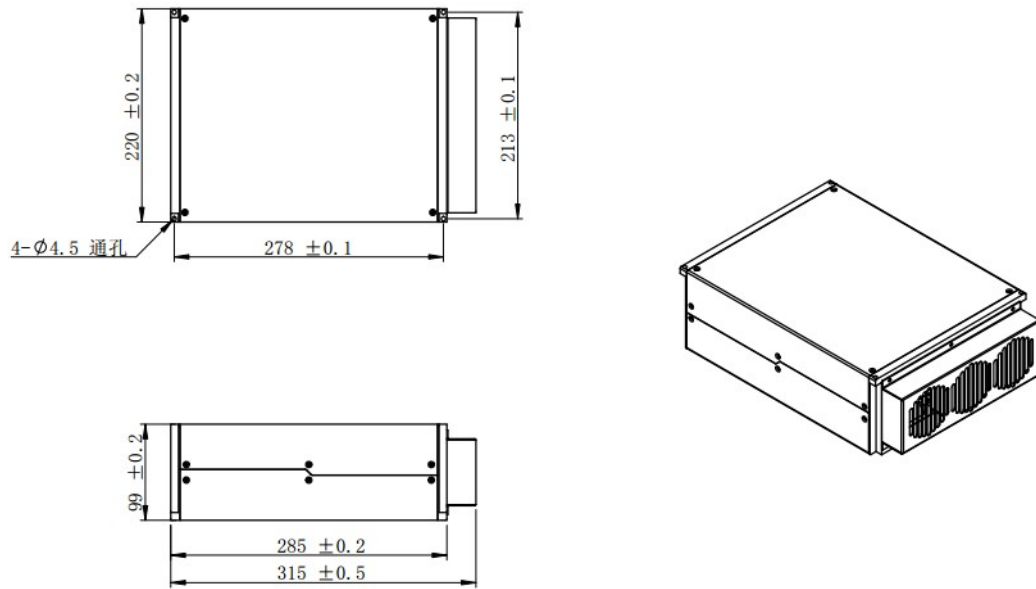
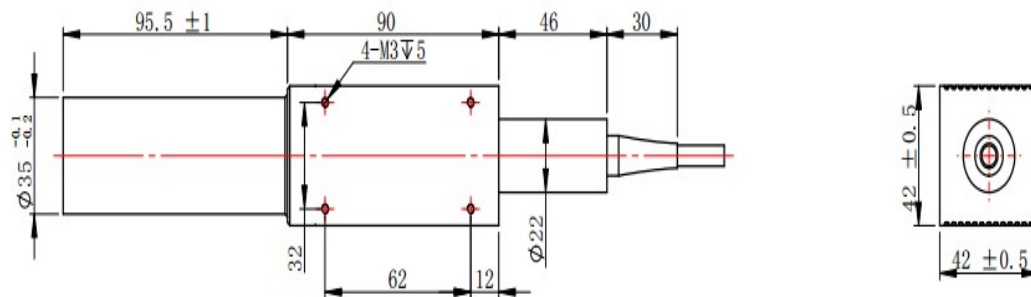

Figure 7 Mechanical Dimensions of the fiber laser module (Unit: mm)

2. Mechanical Dimensions of the output isolator



单位: mm

Figure 8 Mechanical Dimensions of the output isolator (Unit: mm)

3. Mechanical Dimensions of the output fiber cable

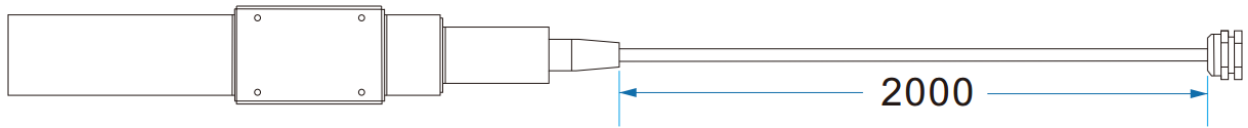

The exact size of isolator please in kind prevail.

2.2 Installation Procedures

- 1) Fix the laser module onto the mounting panel, make sure enough air gaps around the laser module for sufficient air flow.
- 2) Connect the power cables with the 24V DC power supply correctly according to the color code, i.e. Red: DC positive, Black: DC negative, and Olivine: GND.

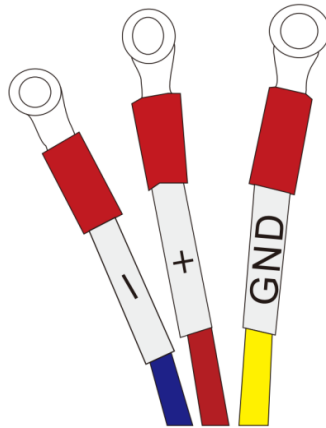

Figure 9 Color code of the power supply cable

- 3) Ensure that the control interface of the external controller can match the laser, and then connect the control cable to the laser and fix it.

3. Control and Monitoring Interfaces

3.1 Control Interface

DB25 behind the power module is the interface used to connect the control system (such as marking machines) to the laser system. Please make sure that the interface is connected firmly before the operation.

The PIN is defined as shown in Figure 10 and Table 6.

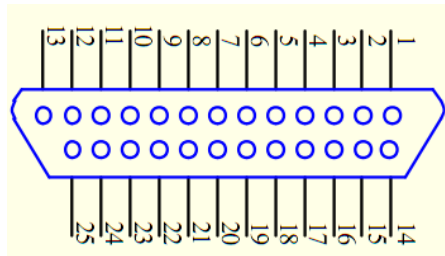

Figure 10 DB25 interface

Table 6 DB25 interface definition

DB25 PIN #	Description
1-8	IP0-IP7 Power Control
10-15	GND Description: PIN10-15 have connected inside fiber laser,only need to connect control card GND with another Pin
16 , 21	Warning signal Description:16 low level,21 high level: Normal 16 low level,21 low level: temperature alarm
19	Laser starting signals (PA) shows that high level is just as open and low level is just as off. If PIN19 at the high level before add the 24VDC main power supply, the fiber laser can't recognize (PA) is on-state

20	Frequency Modulation (TTL)
22	A. Control the pulse width ENABLE B. High Level: Red Beam Turned On; Low Level: Red Beam Turned Off.
18	MO signal for turn on/off high level is just as open and low level is just as off. The laser will shooting after turning on the laser for 12s together with the rising of MO
9,17,23,24,25	No need to connect

3.1.1 Interface Setting

Please set the current of pump laser diode which is the output power through a combination of TTL signals of PIN1~8. The encoding can be set within the range of 0~255 which is corresponding to the 0~100% power output power (the actual optical power output may not be a linear relationship with these settings). Please refer to the description in table 7:

Table 7 Current setting of the MOPA fiber laser

	Setting 1	Setting 2	Setting 3	Setting 4
PIN 1	0	0	0	0
PIN 2	0	0	0	0
PIN 3	0	0	0	0
PIN 4	0	0	0	0
PIN 5	0	0	0	1
PIN 6	0	0	1	1
PIN 7	0	1	1	1
PIN 8	1	1	1	1
Current	~50 %	~75 %	~87.5 %	~93.75 %

DB25 Controlling Time Series Diagram

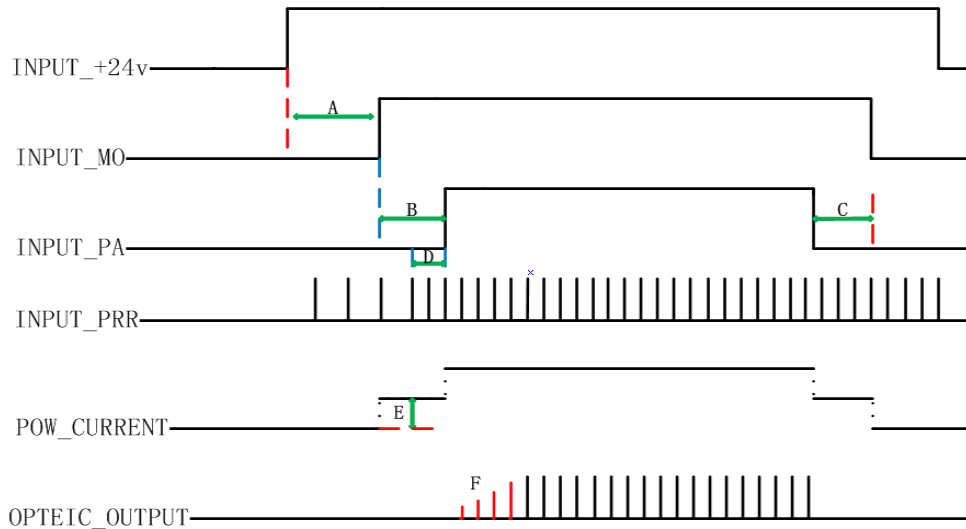

Figure 11 DB25 Controlling Time Series Diagram

- A System initialization time: The laser will shooting after turning on the laser for 12s together with the rising of MO
- B Pump charging time: Range (8ms-35ms), 8ms is recommended.
- C Range: 1ms-8ms, 4ms is recommended.
- D Frequency switching time: Range: 4-8ms, 8ms is recommended.
- E Class II SIMMER: Control the height of the first pulse which can be adjusted via GUI (the supporting software of the laser).
- F The height of the first pulse: This can be adjusted via GUI (the supporting software of the laser).

Remarks: After provide 24V voltage, you need to wait 12s to operate

① **Fiber laser control system self-locking:** If fiber laser received unusual testing signal (Just like: long time not connect control card, high temperature, high frequency signal, low 24V power supply) the fiber laser will stop to receive the instruction. Please again power supply the fiber laser if you need to recover the machine.

3.2 Pulse width control

3.2.1 Pulse width control function Pin:

DB25 Pin2, Pin3, Pin22 not only used to basic control but also pulse width control

Table 8 Fiber laser pulse width control pin and signal

Pin No.	Item	Description
2	Serial Input	Fiber laser serial input, setting data bits synchronize with serial clock rising edge
3	Serial Clock	Serial digital clock, $8\text{kHz} \leq \text{Clock}$ Frequency $\leq 10\text{kHz}$, suggest to use 10KHZ
22	Enable	Pulse width control function: High: Enable, Pin2 and Pin3 to control the pulse width Low or Not connection: Disable

3.2.2 Pulse width control instruction structure

1) Control system send the serial input instruction to fiber laser through Pin2, meanwhile send the clock signal through Pin3. Instruction description will be transmit in binary system, and first transmit the most significant bit.

2) Fiber laser instruction structure as below :



3) 0xA5(A5h) is the data transmission activated byte of activated pulse width control interface,

0xA5 and all data byte is transmit to Pin2 serial input.

The data length is 4 bytes.

The first byte of instruction code is 0x01.

The fiber laser will be at high level status at least 10us in advance before changing “Enable” at any connector, and will be at low level status at least 10us after all change finished.

All instruction design start with 0xA5 byte

4) Please setup low Pin19 before use the extend configuration

3.2.3 Pulse width control instruction code

Table 9 Pulse width control instruction code

Instruction	Instruction Code	Description
Set-up pulse width	0x01	Set-up pulse width (ns)

It will waste 50ns to finish the fiber laser pulse width initialization.

Remarks: If Instruction code transmit 3 * 0x01 instruction, the fiber laser will refuse to receipt.

3.2.4 Pulse width control clock diagram

Below is the 200ns pulse width sample serial clock diagram, The byte order is below when used the 0x01 instruction:

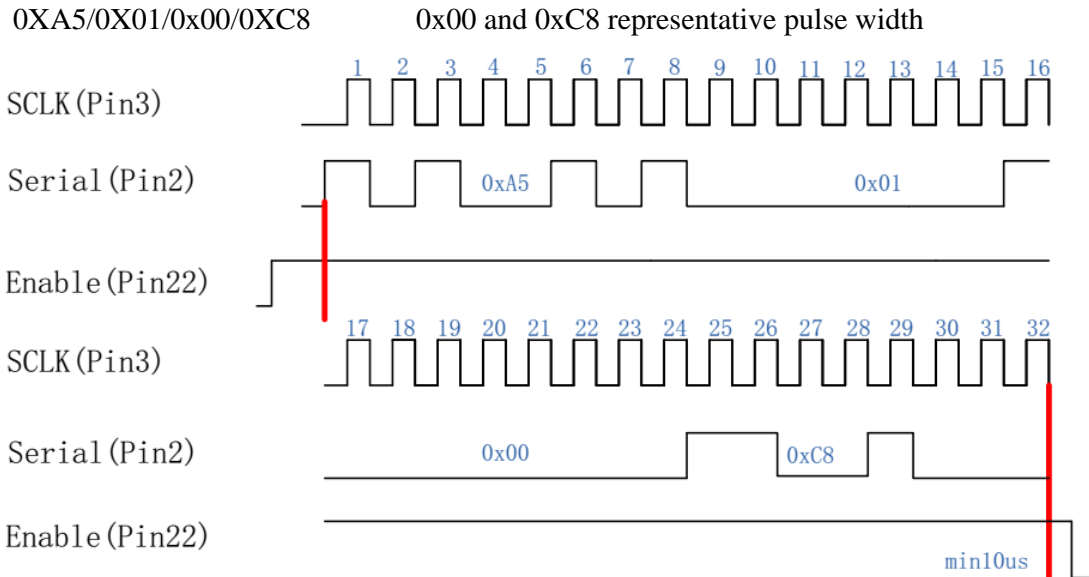

Figure 12 Pulse control clock diagram

The parameters of this instruction are the binary values of the pulse width. Users can compile any values of pulse width, but the laser can only receive the signals of specified pulse width (please refer to the user manual for specific pulse width). If the value of pulse width is out of the range of specified pulse width, the laser will choose the default pulse width set last time.

4. Operation Procedure

4.1 Preparatory examination of the product

- 1) Check the laser casing and the fiber cable for any unexpected conditions;
- 2) Check the connection between laser system and the fiber laser module, and tighten the connection cable.

4.2 Operation Procedure

- 1) Power on the system

Turn on the fiber laser at the same time or after turning on the marking machine. Wait for about 1 minute before move on to the next step. Please take note that the fiber laser will be locked automatically if the laser control card has not been power on within 5s after turning on the laser. If so, please restart the fiber laser in order to function normally.

- 2) Procedures for laser marking

To test the fiber laser, firstly please set the power to 0% and draw a simple figure using the laser marking software, drive the marking and observe the laser output using the frequency doubling piece of pottery and porcelain. Then gradually increase the laser power and change the settings for the marking process. Under normal circumstances, the laser output observed using the frequency doubling piece of pottery and porcelain should be stronger and stronger, or else, turn down the machine and check it.

4.3 Precautions during the laser operation

- 1) Wear laser safety goggle;
- 2) Please stop the laser processing before turning off the fiber laser.

Product warranty and service terms above are for users' reference only. Official service and warranty scope will be specified in the contract.

5. Maintenance, customer service and repair

5.1 Standard warranty

When all products manufactured under purchase orders or specifications are on the delivery, JPT will keep product warranty to the products which have problems in material and technology, and guarantee that products under normal use are in accordance with specifications.

JPT has the right to selectively repair or replace the products which prove to be defective during the warranty period and which shall be returned. The customer will be charges for the cost of repairing the product if the product is not under warranty or if the repair is not cover under the warranty. JPT reserves the right to collect the payment of the products which have problems under normal use.

5.2 Warranty limitation

The above warranties do not apply to defects resulting from improper or inadequate maintenance or calibration by customer; customer or third party supplied software, interfacing or supplies; unauthorized modification; improper use of operation outside the specifications for the product; abuse, negligence, accident, loss or damage in transit; or unauthorized maintenance or repair.

Customers should understand and strictly follow the user manual during operation. Any problems caused by faulty operation are not under warranty. Components and accessories which are not produced in JPT, such as optical fibers, are not within the warranty.

Customer must claim under the warranty no later than thirty days after the claimed defective product is discovered. All claims under this warranty must be made by the customer and no claim will be accepted from any third party.

5.3 Service and Maintenance

CAUTION: There is no operator serviceable part inside. Please refer all servicing to qualified JPT personnel. All requests for repair or replacement under this warranty must be made as soon

as possible after the defect has been noticed and must be directed to JPT or its representative in your area. Items authorized for return by us must be returned in a suitable container. Any damage noted upon receipt of the unit must be documented for appropriate claim against the carrier.

Product warranty and service terms above are for users' reference only. Official service and warranty scope will be specified in the contract.

Thank you for your support to JPT Electronics.