

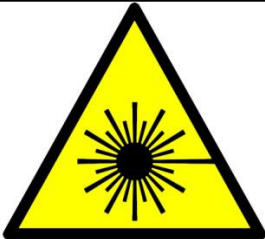

Safety

Please read this user manual carefully before operating the YDFLP fiber laser. It provides essential information regarding safety, product operation, and other necessary reference information. For the purpose of safety operation and maximizing the performance of the fiber laser, please strictly follow the safety notifications as below:

- Make sure the +24VDC power supply is connected in the correct way. Inappropriate connection might spoil the product.
- You can't open the cover of this product without the permission of JPT. It might cause safety issues and invalidate the warranty.
- Please wear laser goggles, as shown in Fig.1, all the time during the operation. This laser module carries a Class 4 Laser rating; it emits invisible laser radiation with a rated average output power of over 10W and a rated peak power of over 7kW. Contact with direct or scattered laser radiation will cause permanent damage to the eyes, burn human tissue, and start fires.
- Attention: Even at 0% power setting, the average output power is still about 90mW.

Table 1 Safety Labels

Symbols	Information
	Laser Warning Triangle -Label of laser emission (Attached near the output fiber)
	CAUTIONS IN USE (Attached on the cover plate)

 <p>$P_o \leq 150W$ $P_p \leq 100KW$ F: 1-2000KHz t: 1-350ns λ: 1040-1200nm CLASS IV LASER PRODUCT</p>	<p>Parameter Information (Attached on the cover plate)</p>
--	--



Figure 1 Laser Safety Goggle

SAFETY	1
1. PRODUCT TOUR	2
1.1 PRODUCT DESCRIPTION.....	2
1.2 PACKAGING LIST.....	3
1.3 OPERATION CONDITIONS AND SAFETY INSTRUCTIONS.....	3
1.4 YDFLP PRODUCT SERIES NAMING CONVENTION.....	4
1.5 TECHNICAL SPECIFICATIONS.....	5
TABLE 4 SPECIFICATIONS OF THE YDFLP-C-M7-S FIBER LASER.....	5
2. INSTALLATION	8
2.1 DIMENSIONS.....	8
2.2 INSTALLATION STEPS.....	9
3.LASER CONNECTOR	10
3.1 POWER INTERFACE.....	10
3.2 RS232 CONNECTOR.....	10
3.3 CONTROL INTERFACE.....	11
3.3.1 Interface Setting.....	12
3.3.2 Pulse width control instruction structure.....	14
3.3.3 Pulse width control instruction code.....	14
3.3.4 Pulse energy control clock diagram.....	15
4.JPT GUI	16
4.1 GUI INSTALLATION.....	16
4.2 INTRODUCTION.....	17
4.3 GUI OPERATION.....	18
4.3.1 Serial Comm Port.....	18
4.3.2 GUI control the emission.....	18
4.4 CHECK THE STATE OF THE LASER.....	22
5. OPERATION PROCEDURE	22
5.1 PREPARATORY EXAMINATION OF THE PRODUCT.....	22
5.2 OPERATION PROCEDURE.....	22
5.3 PRECAUTIONS DURING THE LASER OPERATION.....	23
6. MAINTENANCE, CUSTOMER SERVICE AND REPAIR	23
6.1 STANDARD WARRANTY.....	23
6.2 WARRANTY LIMITATION.....	23
6.3 SERVICE AND MAINTENANCE.....	24
6. 4 GUI CONTROL.....	24

1. Product Tour

1.1 Product Description

The JPT YDFLP pulsed fiber laser adopts the MOPA (Master Oscillator Power Amplifier) configuration, in which a semiconductor laser diode serves as the master oscillator and the fiber amplifiers boost the output power. For this MOPA pulsed fiber laser, the pulse width and pulse repetition frequency are able to be adjusted independently. By changing the pulse width of the fiber laser, the peak power of this MOPA fiber laser can be maintained at the same level for different pulse repetition frequency. This feature makes the product an ideal laser source for various industrial applications.

The MOPA fiber lasers get pumps through fiber couplers, which enables them with higher slope efficiency compared to conventional solid state lasers. The fiber laser is more compact and easy to carry, because it only uses three cooling fans to effectively remove the heat generated inside the chamber. Besides, the whole fiber based laser cavity enables higher beam quality of the laser output.

JPT MOPA fiber laser adopts the standard DB25 interface, and it's power supplied with 24V/5A DC, which makes it a good compatibility. A photograph of a typical JPT MOPA fiber laser is as shown below.



Figure 2 JPT C-type MOPA Fiber Laser

1.2 Packaging List

Table 2 Packaging List of YDFLP

Items	Quantity
Fiber Laser source	1
24V Power supply Cable	1
db25 male to female adapter	1
USB Data Line(GUI)	1
Specification List	1
Precautions	1

1.3 Operation conditions and safety instructions

In order to maintain good performance and reliability of this product, please operate the laser under conditions as below:

- (1) This fiber laser shall be operated with 24V/5A DC power supply; **wrong connection will damage the fiber laser, which lead to the laser can't work.**
- (2) There should be 10-cm-wide air gaps in front and behind the fiber laser chamber, and the air flow direction should be the same with the direction of the fiber laser system; **Short ventilation distance and wrong air flow direction will lead to the fiber laser can't work.**
- (3) The operating temperature should be 0~40°C; the fiber laser will alarm internal if the temperature above 40°C; it's a protection action, in order to insure the long time operational reliability.
- (4) Please keep the fiber laser source clean during the operation, especially for the fiber pigtail and output isolator; please remember cover the isolator when the laser is unworking. **Dust on the isolator will cause heating and lens damage, which results in the laser output power attenuation**
- (5) Please ensure the power is off before install and uninstall this fiber laser.
- (6) Never look at the fiber laser head, **and please wear laser goggle when operate this fiber laser;**
- (7) The YDFLP-C-M7 contains 16 waveform: 1ns, continuous, 2ns,4ns,6ns,8ns,13ns,20ns,30ns, 45ns,60ns,80ns,100ns,150ns,200ns,250ns,350ns.
If you need other pulse width, please contact us for customization.

1.4 YDFLP Product Series Naming Convention

Table 3 Naming Convention for Pulsed Fiber Laser

YDFLP -X-XX-XX-X-X

1 2 3 4 5 6

1. Product name.	YDFLP Ytterbium Doped Fiber Laser Pulse				
2. Size	C: Compact				
3. Average Output power (optional).	10W~200W				
4. Product Series (optional).	Pulse width adjustable	M Series	M1(+)		
			M6(+)		
			M7		
	LM1 Series		large pulse width		
	Pulse width fixed	LP series			
5. Optical Fiber Types	S		Single mode		
	L		Low mode		
	H		High mode		
6. Customized	Without: Standard product;		R:Built-in red pilot laser		

Table 3 Naming Convention for Pulsed Fiber Laser

For example:

YDFLP - C-20—M1+—S: Means this is a compact size product of M1+ using single mode type of optical fiber with the nominal output power @ 20W.

YDFLP - 30—M1+—L—R: Means this is a customized product of M1+ using low mode type of optical fiber with the nominal output power @ 30W,Integrated built-in red pilot laser.

1.5 Technical Specifications

Table 4 Specifications of the YDFLP-C-M7-S fiber laser

Laser Type	Unit	MOPA
Product Model		YDFLPC-30-M7-S
Average Output Power	W	>30
M2		<1.3
Output Fiber Length	m	2m (Customize)
Pulse Energy	mJ	0.8
Full Power Frequency Range	kHz	37-4000
Adjustable Frequency Range	kHz	1-4000
Pulse Width Range	ns	2-350
Output Power Stability	%	<5
Cooling Method		Air Cooling
Supply Voltage	V	24
Current consumption	A	<5
Environmental Supply Current	A	>5
Power Consumption (20 °C)	W	<120
Central Wavelength	nm	1064
FWHM (nm) @3dB	nm	< 15
Polarization		Random
Anti-Reflection Protection		Yes
Output Beam Diameter (mm)	mm	7±0.5
Power Range	%	0 ~ 100
Operation Temperature Range	°C	0 ~ 40
Storage Temperature Range	°C	-10 ~ 60
Dimension	cm	245*200*65
Package size	mm	481*309*136
Weight	kg	Net:4.47 G.W.:6.32

Table 5 YDFLP-C-M7-S Threshold Frequency

(ns)	C-30-M7-S
1	CW
2	1300
4	750
6	480
8	375
13	250
20	170
30	135
45	110
60	100
80	90
100	80
150	45
200	37
250	37
350	37

★ for laser safety and long lifetime, when set ≥ 80 ns, ≥ 400 kHz, frequency will be limited at 400kHz,

***Above the cut-off Frequency value is the fiber laser full power output range, oppositely,below the cut-off frequency value is the cut-off power output range. That means the fiber laser will reduce the output power to protect the fiber laser when below the cut-off frequency value. Below is the chart that shows the change between frequency and output:**

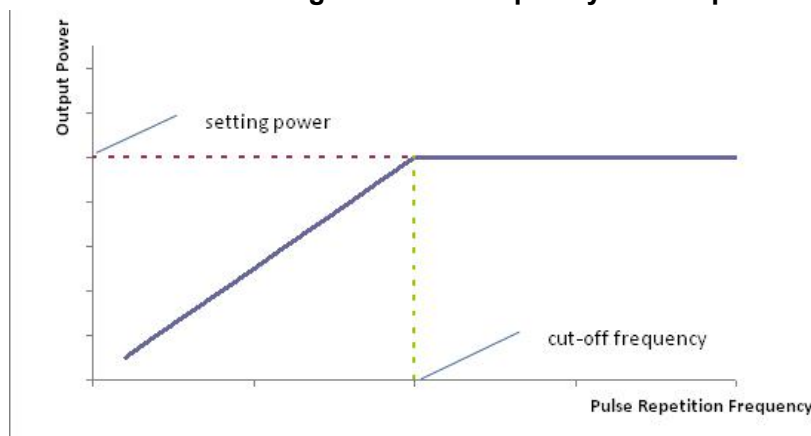

Figure 3 Cut-off Frequency & Output power relationship charts

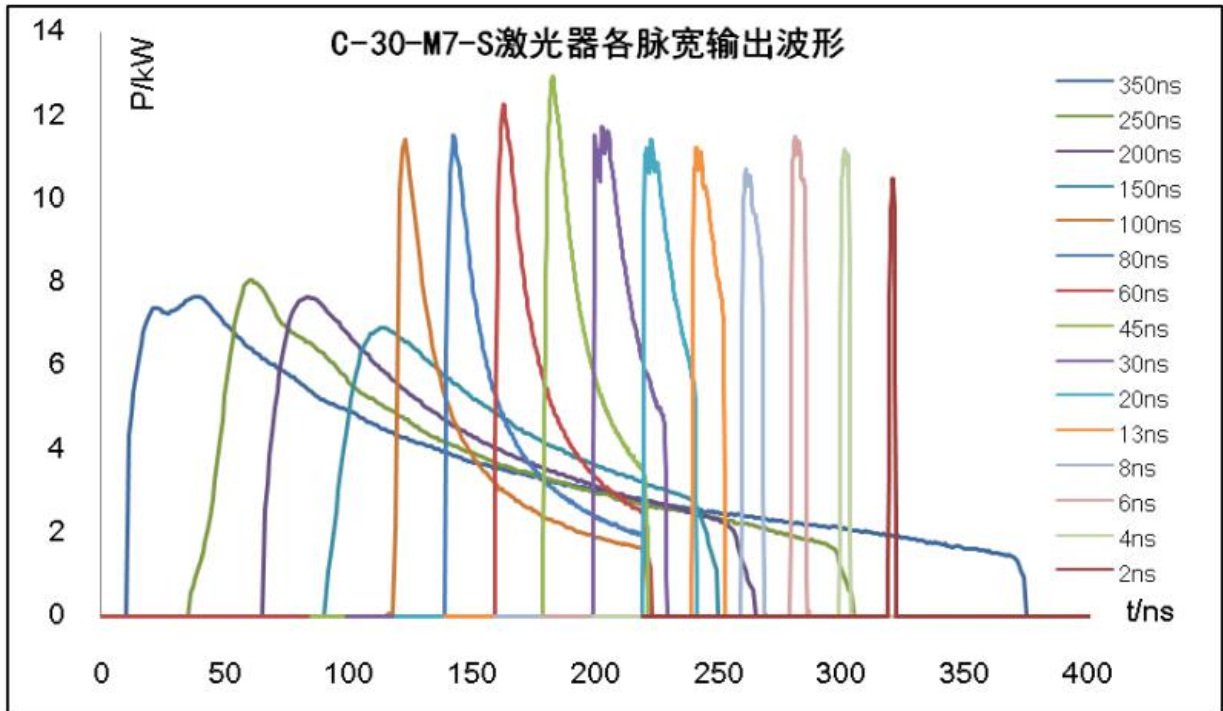

Figure 4 Waveform

2. Installation

2.1 Dimension

1. Dimension of main body

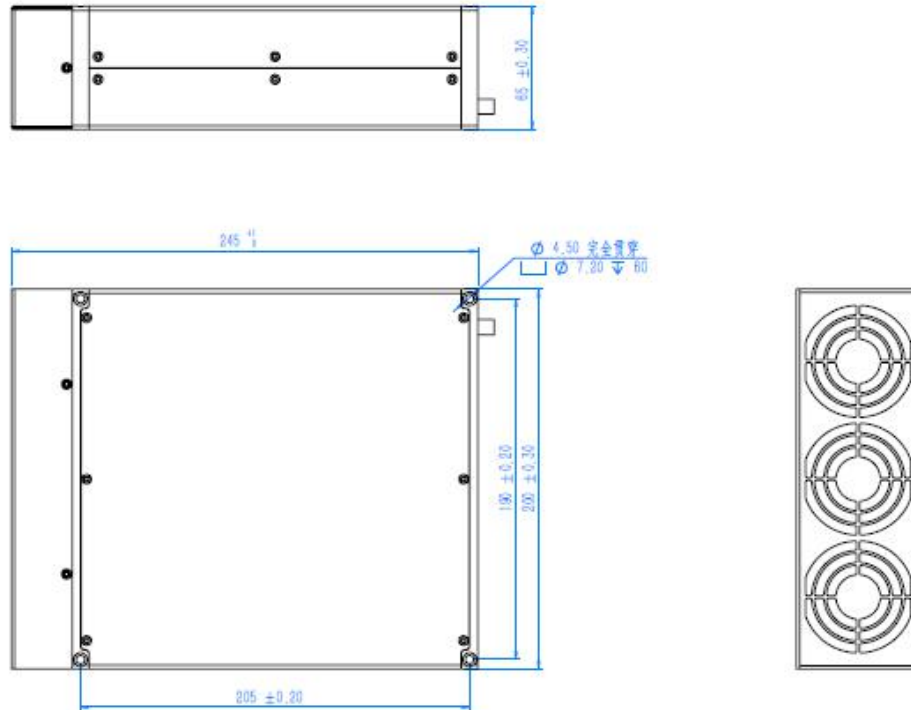

Figure 5 Mechanical Dimension of Fiber Laser Module (Unit: mm)

2. Mechanical Dimension of the output isolator.

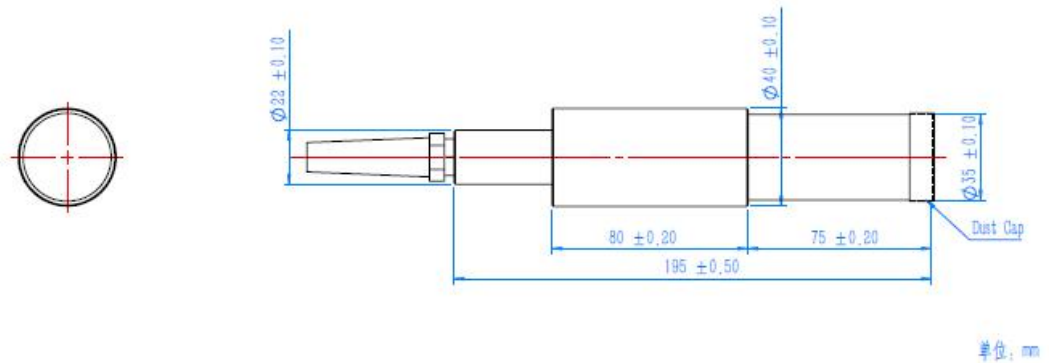
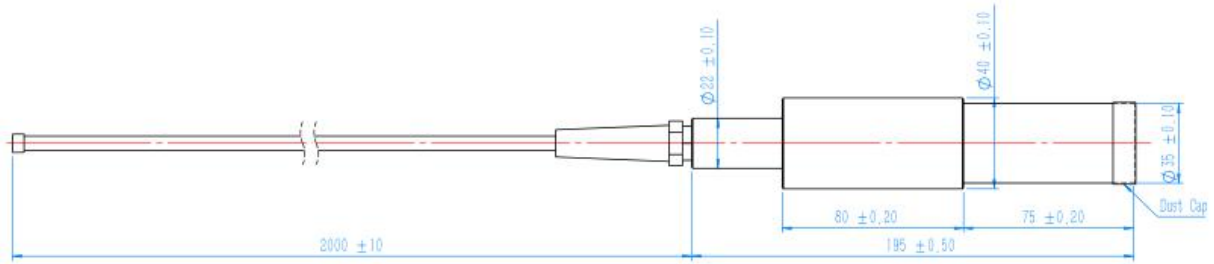

Figure 6 Mechanical Dimension of the output isolator (Unit: mm)

3. Mechanical Dimension of the output fiber cable



The exact size of laser head. (Unit: mm) (cable length can be customized.)

2.2 Installation Steps

- 1) Fix the laser module onto the mounting panel, make sure enough air gap around the laser module for sufficient air flow.
- 2) To connect the power supply cable to the 24 v dc power supply, and make sure that the dc power supply can provide enough output power. Please note the polarity of the cable. Power supply cable “+” is DC positive and “-” is DC negative and GND is ground wire.

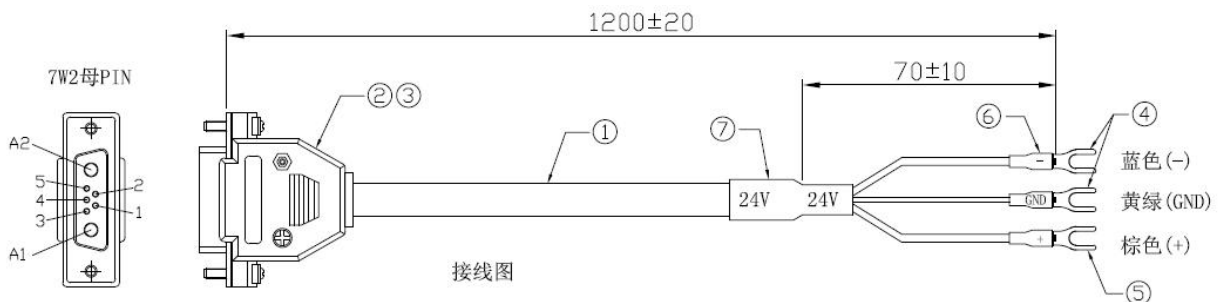

Figure 8 Color code of the power supply cable

- 3) Ensure that the control interface of the external controller can match the laser, and then connect the control cable to the laser and fix it.

3.Laser connector

3.1 Power Supply Interface

The power connector is DB-7W2 type (Male), and the pins are as follow Table 6:

Table 6

PIN#	Description
A1	+24VDC, power supply for laser
A2	24VDC negative
1, 3, 4	No need to connect
2	+24VDC, control Circuit Power supply
5	Connect to ground

PIN_A1 and PIN_2 in Table 6 connect to “+” in Figure 8 , PIN_A2 connect to “-” ,PIN_ 5 Connect to “GND”. If need power separately, please separate the PIN_A1 and PIN_2.

3.2 RS232 connector

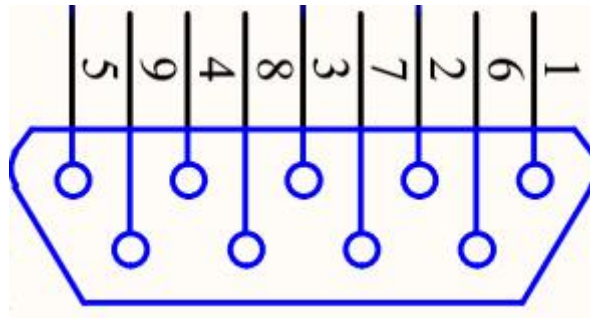

Figure 9 RS232 connector DB9

Table 7

PIN#	Description
1, 4, 6-9	No need to connect
2	RxD
3	TxD
5	GND

3.3 Control Interface

DB25 behind the power module is the interface used to connect the control system (such as marking machines) to the laser system. Please make sure that the interface is connected firmly before the operation.

The PIN is defined as shown in Figure 10 and Table 8.

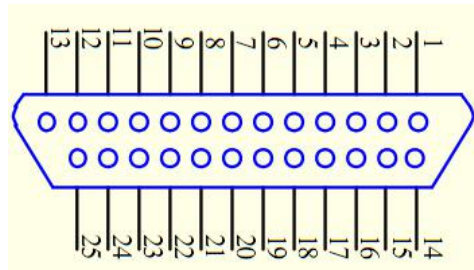

Figure 10 DB25 Interface

Table 8 DB25 interface definition

DB25 PIN #	Description
1-8	IP0-IP7 Power Control
9	Signal of power save, (this function is available in GUI) Rising edge is effective.
10-15	GND Description: PIN10-15 have connected with each other inside fiber laser, control card GND only need to control with one of them.
16, 21	Warning signal Description: 16 low level, 21 high level: Normal 16 low level, 21 low level: temperature alarm
19	Laser starting signals (PA) shows that high level is open and low level is just as off. The system can receive the PA only after the laser is on for 12s and the MO is H.
20	Frequency Modulation (TTL)

22	A. Control the pulse width ENABLE B. High Level: Red Beam Turn On; Low Level: Red Beam Turn Off.
23	Emergency Stop signal High level: Normal Low level: Emergency Stop (this function is available in GUI) Emergency top signal for low to high, need to detect the rising edge of MO firstly, then the laser come out again.
18	MO signal for turn on/off high level is just as open and low level is just as off. The laser will shooting after turning on the laser for 12s together with the rising of MO
17,24,25	No need to connect

Notes:DB25 5.4v >high level>4.6V 0.5v>low level>0v

3.3.1 Interface Setting

Please set the current of pump laser diode which is the output power through a combination of TTL signals of PIN1~8. The encoding can be set within the range of 0~255 which is corresponding to the 0~100% power output power (the actual optical power output may not be a linear relationship with these settings). Please refer to the description in table 9:

Table 9 Current setting of the MOPA fiber laser

	Setting 1	Setting 2	Setting 3	Setting 4
PIN 1	0	0	0	0
PIN 2	0	0	0	0
PIN 3	0	0	0	0
PIN 4	0	0	0	0
PIN 5	0	0	0	1
PIN 6	0	0	1	1
PIN 7	0	1	1	1
PIN 8	1	1	1	1
Current	~50 %	~75 %	~87.5 %	~93.75 %

DB25 Controlling Time Series Diagram

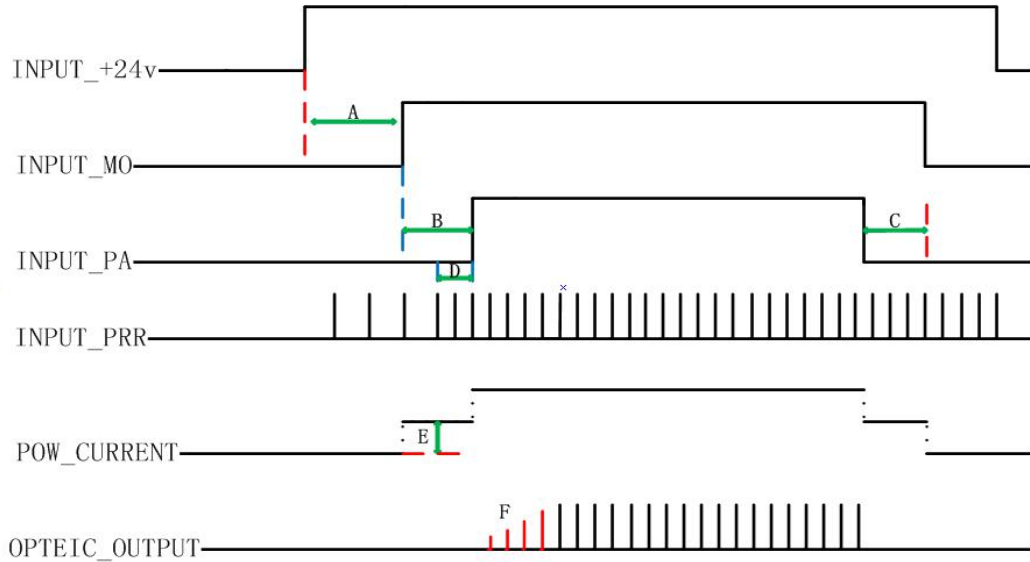

Figure 11 DB25 control sequence diagram

- A System initialization time: The laser will shooting after the laser is on for 12s together with the rising of MO.
- B Pump charging time: Range (8ms-35ms), 8ms is recommended.
- C Range: 1ms-8ms, 4ms is recommended.
- D Frequency switching time: Range: 4-8ms, 8ms is recommended.
- E Class II SIMMER: Control the height of the first pulse which can be adjusted via GUI (the supporting software of the laser).
- F The height of the first pulse: This can be adjusted via GUI (the supporting software of the laser).

Notes:

After the laser provided 24 v voltage, please wait 12 s to do the follow-up operation.

① **Fiber laser control system self-locking function:** If fiber laser received unusual testing signal (Just like: long time no connect control card, high temperature, high frequency signal, low 24V power supply) the fiber laser will stop to receive the instruction. Please turn on the fiber laser power supply again if you want to recover the machine.

DB25 Pin2, Pin3, Pin22 are not only used to control basic function, but also pulse width.

Table 10 Fiber laser pulse width control pin and signal

Pin#	Item	Description
2	Serial Input	Fiber laser serial input, setting data bits synchronize with serial clock rising edge.
3	Serial Clock	Serial digital clock, $8\text{kHz} \leq \text{Clock Frequency} \leq 10\text{kHz}$, 10KHZ is recommended.
22	Enable	Pulse width control function: High: Enable, Pin2 and Pin3 to control the pulse width Low or Not connection: Disable

3.3.2 Pulse width control instruction structure

1) Control system send the serial input instruction to fiber laser through Pin2, meanwhile send the clock signal through Pin3. Instruction description will be transmit in binary system, and first transmit the most significant bit.

2) Fiber laser instruction structure as below :

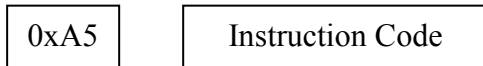

3) 0xA5(A5h) is the data transmission activated byte of activated pulse width control interface, 0xA5 and all data byte is transmit to Pin2 serial input.

The data length is 4 bytes.

The first byte of instruction code is 0x01.

The fiber laser will be at high level status at least 10us in advance before changing “Enable” at any connector, and will be at low level status at least 10us after all change finished.

All instruction design start with 0xA5 byte

4) Please set up low Pin19 before use the extend configuration.

3.3.3 Pulse width control instruction code

Table 11 Pulse width control instruction code

Instruction	Instruction Code	Description
Set-up pulse width	0x01	Set-up pulse width (ns)

It takes less than 50ns to finish the fiber laser pulse width initialization.

Remarks: If Instruction code transmit 3 * 0x01 instruction, that will not be accept by the laser..

3.3.4 Pulse energy control clock diagram

Below is the 200ns pulse width sample serial clock diagram, used the 0x01 instruction:
 0xA5/0X01/0x00/0XC8 0x00 and 0xC8 representative pulse width

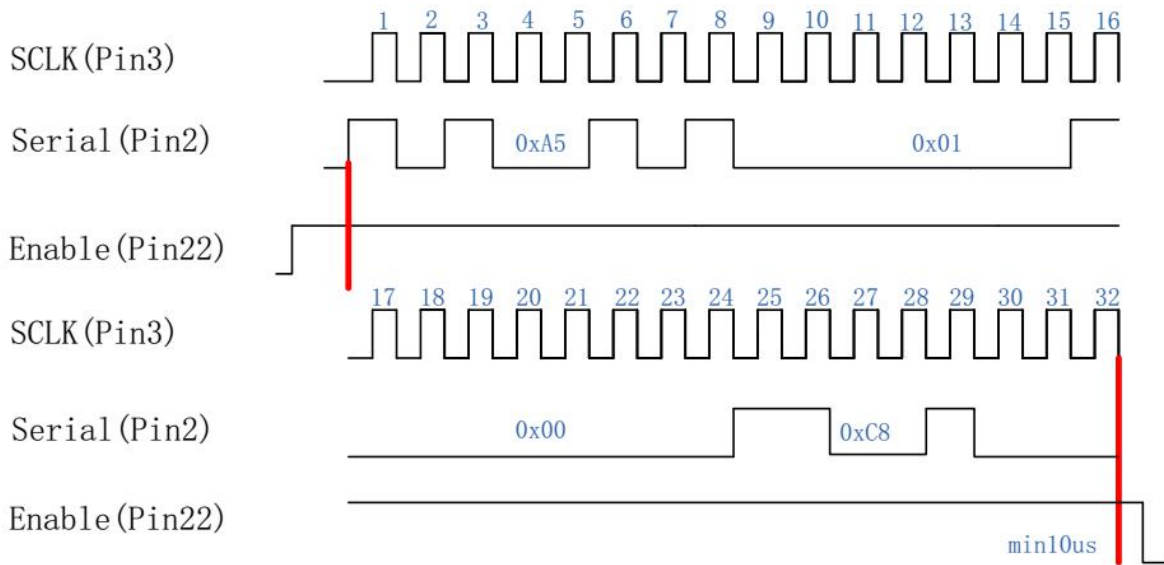

Figure 12 Pulse control clock diagram

The parameters of this instruction are the binary values of the pulse width. Users can compile any values of pulse width, but the laser can only receive the signals of specified pulse width (please refer to the user manual for specific pulse width). If the value of pulse width is out of the range of specified pulse width, the laser will choose the default pulse width set last time.

4.JPT GUI

4.1 GUI installation

4.1 软件的安装

安装包



安装驱动

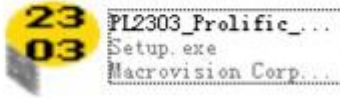

安装软件库



打开软件



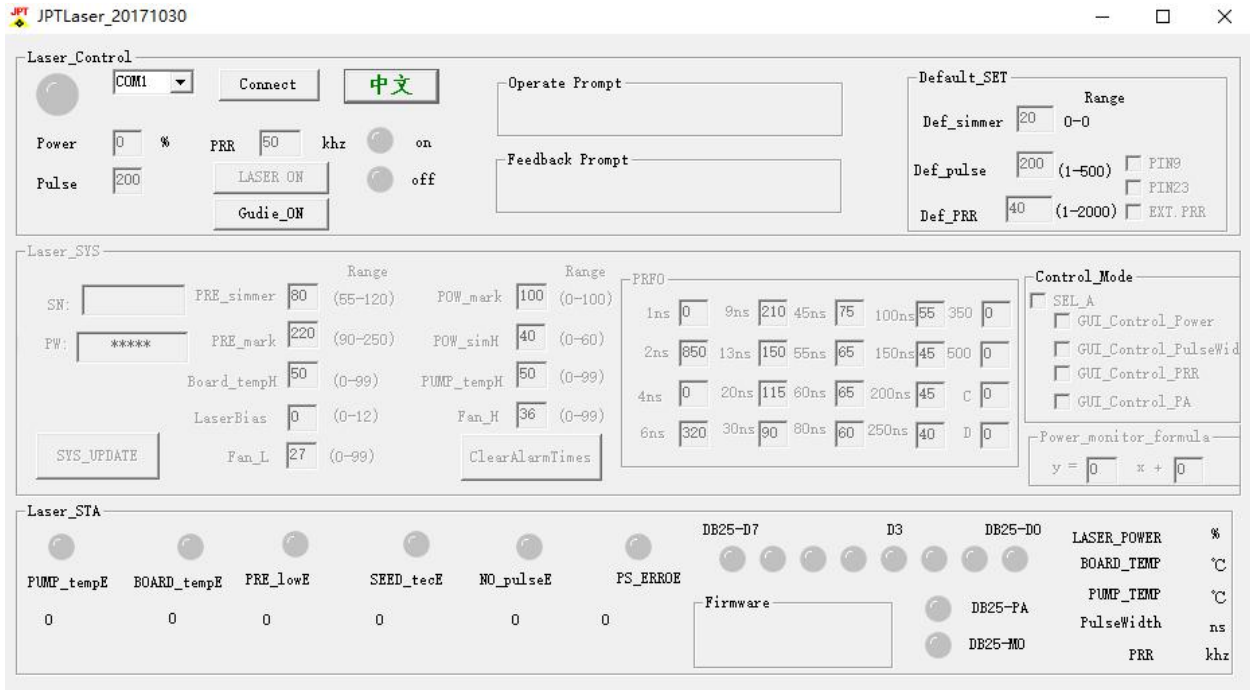

4.2 Introduction

1. JPT laser GUI software has: laser control, setting the default parameters, operation tips, prompt feedback, setting the control mode and the alarm monitoring. In addition, DB25 interface monitoring and internal parameter monitoring functions are available in GUI.
2. The parameter setting of the software is with immediate effect, do not need to restart the laser.
3. Default parameters and control mode setting have the function of saving data automatically after power down.
4. Only can set the power parameters in the laser control bar during emission, (including DB25 and GUI), other settings are not allowed during emission, or there will be prompt warning tip as the below figure.

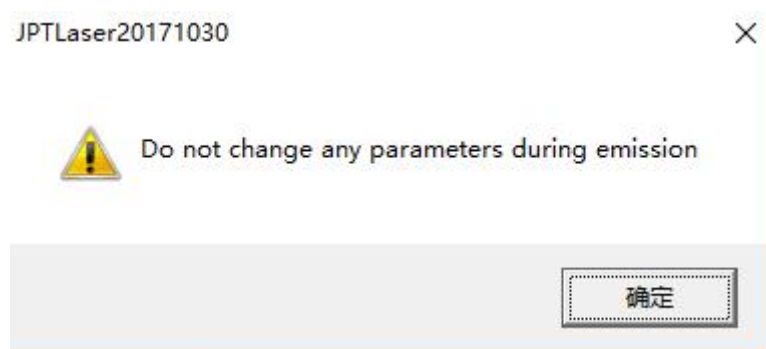

4.3 GUI Operation

4.3.1 Serial Comm Port

After the connect the cable to check the port number: my computer - > properties - > hardware - > device manager - >

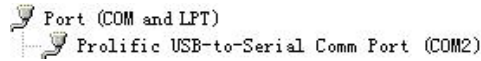

If the serial number of COM is larger than the COM4 than change the COM number within 4.

Click the Serial Comm Number as follows:



4.3.2 GUI control the emission

(1) Choose the GUI control Mode

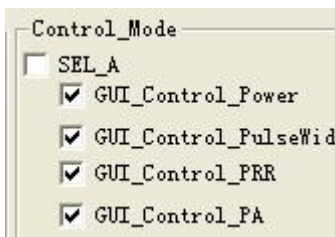

If you choose the GUI control, this setting will be saved automatically after the power down, so please cancel the GUI control mode, if you don't want to use the GUI to control the laser.

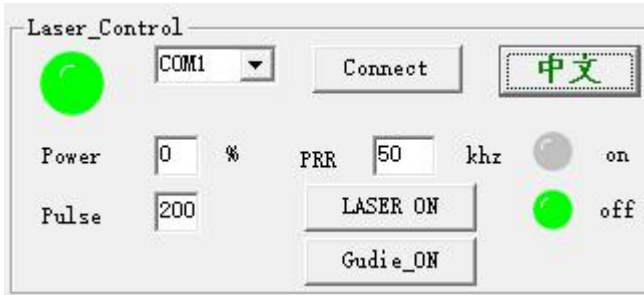

Laser can work under the parameters set at GUI which can control the power, pulse width and frequency.

Laser On: Hit the button “on ” after set the parameters, and the button “off” is laser off.

Language: Switch the button “中文” and “English” to choose the language.

(2) Default Parameters Setting

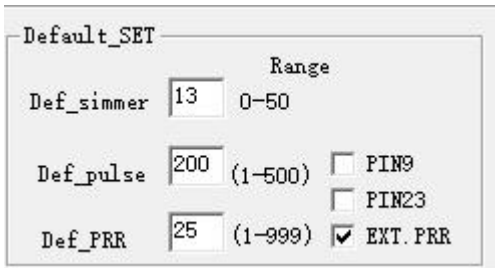

Laser default SIMMER set can be achieved by "default Settings" option, default parameters such as default pulse width and default frequency, parameter settings take effect immediately and save automatically after power down.

The default SIMMER: can control the height of the first pulse, the higher the value, the larger the first pulse.

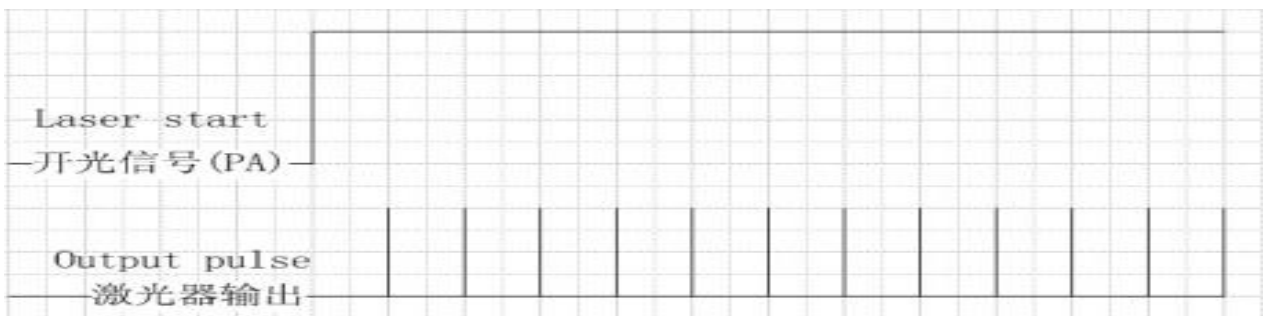

[APPROPRIATE SIMMER]

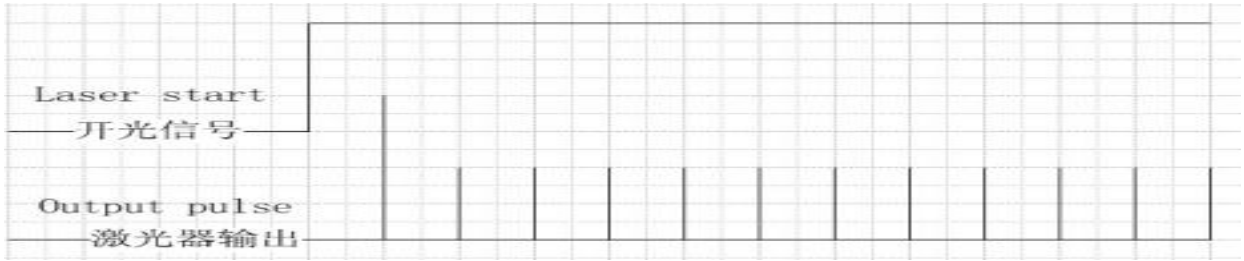

[OVERHIGH SIMMER]

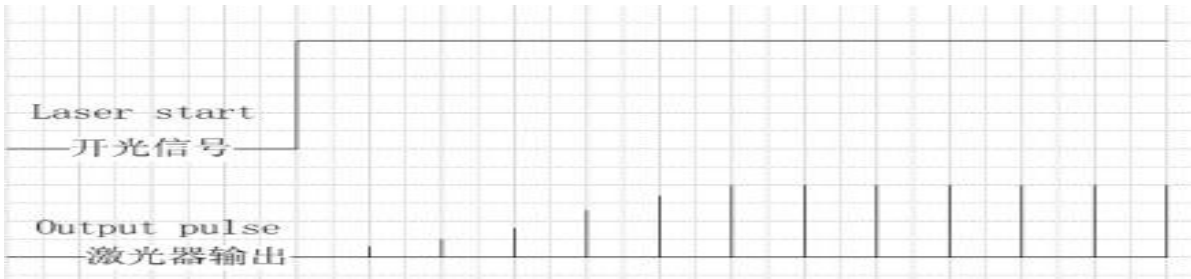

[OVERLOW SIMMER]

Default Frequency: In internal frequency mode, if there is no external frequency signal, the system run in the default frequency.

Default width: If the external system cannot control pulse width, the system is in the default output pulse width.

External Frequency: when checking for external frequency model (the final output of the laser and external frequency signal are synchronous, if the control card is optimized for external frequency signal, you can choose this mode). When not check the external mode the laser work as internal frequency (the system will calculate the external frequency signal firstly, and then their parameters of pulse signal, if the control card without external frequency signal can use the model to define the default frequency of laser)

Default External Frequency Mode

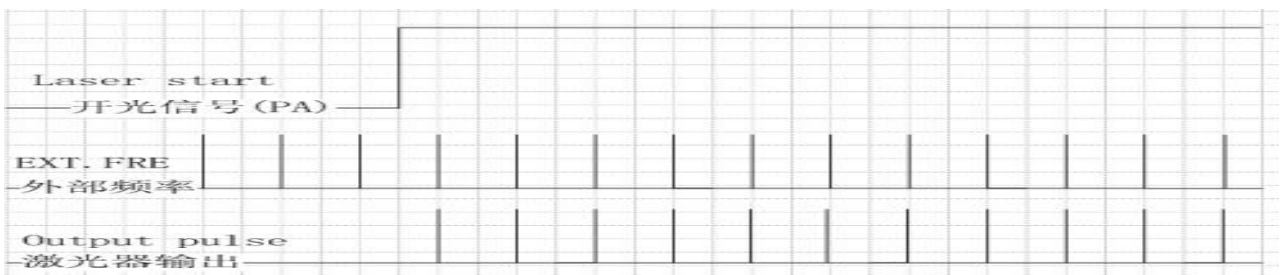

External Frequency

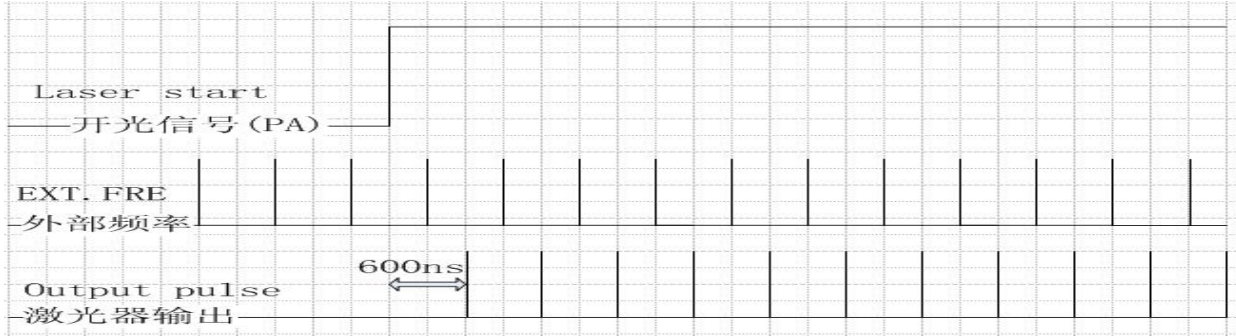

Internal Frequency

(3) The Fan Speed Control

When the temperature is and higher than Fan_L, the fan starts to work. And the temperature is up to Fan_H, the fan works at maximum speed.

1. The fan works at maximum speed for 5s after the power is on, then steps into the stage of speed control.
2. If the sensor temperature below Fan_L, the fan does not work. (At the beginning, sensor temperature is higher than Fan_L, then lower than this value, the fan works at fixed speed.)
3. The Fan works at speed control when the sensor temperature between between Fan_L and Fan_H, the closer the sensor temperature gets to the Fan_H, the closer the fans run at maximum speed.
4. The fans work at maximum speed when the temperature is higher than Fan_H.

(4) Power Latching and Emergency Stop Signal Control

Default_SET		Range	
Def_simmer	13	0-50	
Def_pulse	200	(1-500)	<input checked="" type="checkbox"/> PIN9
			<input checked="" type="checkbox"/> PIN23
Def_PRR	25	(1-999)	<input checked="" type="checkbox"/> EXT. PRR

PIN9 is power latch signal and the function is enabled if checked, rising edge is effective. The default is not checked.

PIN23 is for stop signal and the function is enabled if checked, low level effective, the default is not checked.

4.4 Check the state of the laser

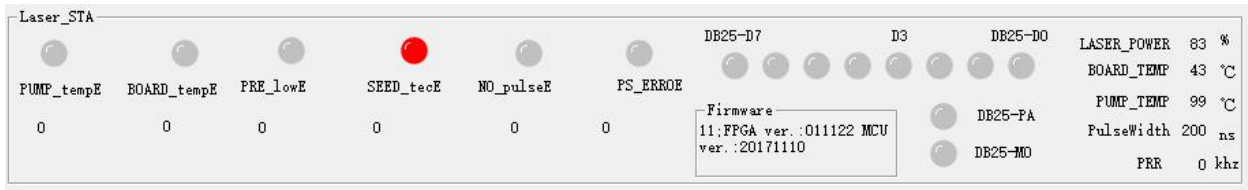

The laser working parameters and alarm condition can be observed through GUI.

The warming times will be sent to the GUI every time when the laser was turned on.

The DB25 - D0, D3, DB25 - D7, DB25 - PA, DB25 - MO are the states that receive from DB25 laser power, PA and MO ports. The light is on when at high level and low level, off.

The "pulse width" and "frequency" value are the parameters that are being used by the laser.

The "laser power" is the percentage converted from pump sources current.

5. Operation Procedure

5.1 Preparatory examination of the product

- 1) Check the laser casing and the fiber cable for any unexpected conditions;
- 2) Check the connection between laser system and the fiber laser module, and tighten the connection cable.

5.2 Operation Procedure

- 1) Power on the system

Turn on the fiber laser at the same time or after turning on the marking machine. Wait for about 1 minute before move on to the next step. Please take note that the fiber laser will be locked automatically if the laser control card has not been power on within 5s after turning on the laser. If so, please restart the fiber laser in order to function normally.

- 2) Procedures for laser marking

To test the fiber laser, firstly please set the power to 0% and draw a simple figure using the laser marking software, drive the marking and observe the laser output using the frequency doubling piece of pottery and porcelain. Then gradually increase the laser power and change the settings for the marking process. Under normal circumstances, the laser output observed using the

frequency doubling piece of pottery and porcelain should be stronger and stronger, or else, turn down the machine and check it.

5.3 Precautions during the laser operation

- 1) Wear laser safety goggle;
- 2) Please stop the laser processing before turning off the fiber laser.

Product warranty and service terms above are for users' reference only. Official service and warranty scope will be specified in the contract.

6. Maintenance, customer service and repair

6.1 Standard warranty

When all products manufactured under purchase orders or specifications are on the delivery, JPT will keep product warranty to the products which have problems in material and technology, and guarantee that products under normal use are in accordance with specifications.

JPT has the right to selectively repair or replace the products which prove to be defective during the warranty and which shall be returned. The customer need to pay the repair charge if the product is not under warranty or if the reparation is not under the warranty. JPT reserves the right to collect the payment of the products which have problems under normal use.

6.2 Warranty limitation

The above warranties do not apply to defects resulting from improper or inadequate maintenance or calibration by customer; customer or third party supplied software, interfacing or supplies; unauthorized modification; improper use of operation outside the specifications for the product; abuse, negligence, accident, loss or damage in transit; or unauthorized maintenance or repair. Customers should understand and strictly follow the user manual during operation. Any problems caused by faulty operation are not under warranty. Components and accessories which are not produced in JPT, such as optical fibers, are not within the warranty.

Customer must claim under the warranty no less than thirty days after the claimed defective product is discovered. All claims under this warranty must be made by the customer and no claim will be accepted from any third party.

6.3 Service and Maintenance

CAUTION: There is no operator serviceable part inside. Please refer all servicing to qualified JPT personnel. All requests for repair or replacement under this warranty must be made as soon as possible after the defect has been noticed and must be directed to JPT or its representative in your area. Items authorized for return by us must be returned in a suitable container. Any damage noted upon receipt of the unit must be documented for appropriate claim against the carrier.

Product warranty and service terms above are for users' reference only. Official service and warranty scope will be specified in the contract.

6.4 GUI Control

JPT laser have be be controlled by JPT GUI software, directly connect to computer, then can be fully controlled.